



# Dual Temp FitSpa

## OWNER'S MANUAL

Revision 4 –Nov 10, 2021







### CERTIFICATE OF AUTHENTICITY

Thank you for your purchase. This certificate hereby verifies that the swim spa and exercise pool you have purchased from a TidalFit™ (May Manufacturing, LLC) authorized dealer is authentic, brand new and original. The swim spa and exercise pool has been crafted and built in the U.S.A in accordance with industry quality standards.

### WARRANTY REGISTRATION

Please activate your warranty and register your spa at [www.TidalFit.com](http://www.TidalFit.com) click SUPPORT then “Click Here to Register Your Spa” or mail the registration card in the back of the Owner’s Manual.

Spa Serial #: \_\_\_\_\_

Spa Model: \_\_\_\_\_

Date Purchased: \_\_\_\_\_

Installation Date: \_\_\_\_\_

Dealer Name: \_\_\_\_\_

 Dealer Telephone #: \_\_\_\_\_

PROUDLY MADE FOR THE WORLD IN THE USA





## Table of Contents

IMPORTANT SAFETY INSTRUCTIONS .....	3
Equipment Assemblies .....	8
Audio Component Warnings .....	12
ELECTRICAL REQUIREMENTS .....	14
SWIM SPA AND EXERCISE POOL START-UP .....	14
Selecting a Location.....	14
General Guidelines.....	14
Outdoor Swim Spa and Exercise Pool Installation Guidelines.....	16
Indoor Swim Spa and Exercise Pool Installation Guidelines.....	17
Electrical Wiring .....	17
60 Hz, 240 V Residential GFCI Wiring Schematic.....	19
50 Hz, 240 V Residential 2 Pole RCD Wiring Schematic.....	20
50 Hz Single, Two and Three Phase Power Wiring .....	21
TidalFit™ Dual Temp FitSpa™ Semi-Inground Swim Spa and Exercise Pool Installation.....	22
Filling the Dual Temp FitSpa with Water.....	29
Powering the Swim Spa and Exercise Pool On .....	30
Testing the GFCI for a 60 Hz System .....	31
Priming Pumps.....	31
Water Preparation.....	32
Rowing and Exercise Equipment Installation and Use.....	33
Rowing Exercise .....	34
Upper Body Workouts.....	34
Run In Place Treadmill with Super Swim Pole.....	36
Advanced Swimming with Super Swim Pole .....	37
TOPSIDE CONTROLLER INSTRUCTIONS FOR HYDROTHERAPY AND SWIM AND EXERCISE POOL SIDES .....	38
Main Screen.....	39
Spa Status .....	39
Navigation .....	40
Messages.....	41

The Set Temperature Screen.....	42
Set Temperature.....	42
Press-and-Hold.....	42
The Spa Screen .....	42
Common Buttons .....	43
Values Increment / Decrement .....	43
Invert Panel .....	43
Exiting Screens.....	44
Page Right/Left.....	45
Page Up / Down.....	45
Programming, Etc. ....	45
Dual Temperature Ranges (High vs. Low).....	46
Heat Mode – Ready vs. Rest.....	47
Circulation Mode (See Pumps, for other circulation modes).....	47
Ready-in-Rest Mode.....	47
Priming Mode – M019* .....	47
Priming the Pumps .....	48
Exiting Priming Mode.....	48
Pumps.....	49
Non-Circ Systems.....	49
Circulation Pump Modes.....	49
Filtration and Ozone .....	49
Freeze Protection .....	49
Time of Day.....	50
Set the Time-of-Day.....	50
Adjusting Filtration .....	51
Main Filtration .....	51
Filter Cycle 2 - Optional Filtration.....	51
Circulation Pump Modes.....	52
Purge Cycles .....	52
The Meaning of Filter Cycles .....	52
Additonal Settings.....	52

Light Cycle Option .....	52
Auxiliary Panels .....	53
Specific Buttons for Specific Devices.....	53
Restricting Operation .....	53
Locking and Unlocking.....	54
Additional Settings .....	54
Hold Mode – M037* .....	54
Utilities .....	55
Units Screen .....	56
Information .....	58
System Information.....	58
GFCI Test Feature.....	59
General Messages.....	60
Sensor Related Messages.....	62
System Related Messages .....	63
Miscellaneous Messages.....	64
Reminder Messages .....	64
<b>MAINTAINING THE SWIM SPA AND EXERCISE POOL .....</b>	<b>65</b>
Draining the Swim Spa and Exercise Pool.....	65
Pillow Care.....	66
Jet Care .....	66
Removing, Installing and Cleaning Filters.....	67
Storing or Winterizing the Swim Spa and Exercise Pool.....	68
Swim Spa and Exercise Pool Cabinet Care.....	68
Cleaning the Swim Spa and Exercise Pool Interior.....	68
Swim Spa and Exercise Pool Cover Use, Installation and Care .....	69
Chemical Treatment of Water .....	70
<b>TIDALFIT™ WARRANTY.....</b>	<b>711</b>



## List of Figures

Figure 1. GFCI Wiring Schematic for 60 Hz Systems.....	19
Figure 2. Proper Voltage Readings Across Terminals on House Breaker Box, Swim Spa and Exercise Pool System Box and GFCI.....	20
Figure 3. Wiring Schematic for 50 Hz Systems .....	20
Figure 4. Single Phase Power – TN and TT Electrical Systems.....	21
Figure 5. Two Phase Power – TN and TT Electrical Systems.....	21
Figure 6. Three Phase Power – TN and TT Electrical Systems .....	22
Figure 7. Ice Bag Positioning in Excavation .....	23
Figure 8. Swim Spa And Exercise Pool Position in Excavation on Ice Bag.....	24
Figure 9. Excavation Cross Section .....	25
Figure 10. Swim Spa and Exercise Pool Side .....	25
Figure 11. Swim Spa and Exercise Pool Side and Hydrotherapy Spa Positioning .....	26
Figure 12. Swim Spa and Exercise Pool Side and Hydrotherapy Spa Position for Attachment.....	26
Figure 13. Latch Location on Hydrotherapy and Swim and Exercise Pool Frames .....	27
Figure 14. Latch Action Toggle Clamp Locations.....	28
Figure 15. Middle Latch Location on Hydrotherapy and Swim and Exercise Pool Frames .....	28
Figure 16. Toggle Latch and Hook Fastener .....	28
Figure 17. Hydrotherapy and Swim Spa and Exercise Pool Top Edge and Tile Alignment .....	29
Figure 18. Filling Location in Filter Housing .....	30
Figure 19. Rowing Equipment and Tension Cord Mount Locations .....	33
Figure 20. Tension Cord Mount Locations .....	35
Figure 21. Super Swim Pole Attachment Location .....	36
Figure 22. TidalFit™ Dual Temp FitSpa™ Three Pump Topside Controller Face.....	38
Figure 23. Main Screen Layout .....	39
Figure 24. Hose Bib Opening Instructions.....	65

# **IMPORTANT SAFETY INSTRUCTIONS**

## **IMPORTANTES CONSIGNES DE SÉCURITÉ**

**May Manufacturing, LLC dba TidalFit™ or any affiliates** are not responsible for any defects, failure or damage resulting from improper installation or use, abnormal environmental conditions, cellular signal reception or transmission, and/or viruses or other software problems introduced into this product or other products that are used or purchased products by the user.

**PLEASE TAKE THE TIME TO READ ALL OF THESE WARNINGS AND CAUTIONS PRIOR TO USING THE SPA.**

**PRIÈRE DE LIRE ATTENTIVEMENT TOUTES CES MISES EN GARDE AVANT D'UTILISER LE SPA.**

PLEASE, be a responsible spa owner. When installing and using this spa, always adhere to basic safety precautions. Be sure to list emergency telephone numbers at the telephone nearest the spa, including physician, hospital, ambulance, police, and the fire department. Be certain to explain safety precautions to all new or occasional users of the spa. Remember, they may not be aware of the possible risks associated with the spa water temperature. Have at least one family member learn CPR (cardiopulmonary resuscitation).

**IT COULD SAVE A LIFE!**

VEUILLEZ agir de façon responsable en tant que propriétaire de spa. Lorsque vous installez et utilisez ce spa, veuillez prendre les précautions de sécurité de base en tout temps. Conservez près du spa une liste indiquant les numéros de téléphone d'urgence, notamment le médecin, l'hôpital, l'ambulance, la police et les pompiers. Veillez à expliquer les précautions de sécurité à tous ceux qui utilisent votre spa occasionnellement ou pour la première fois. Rappelez-vous qu'ils ne sont probablement pas au courant des risques inhérents à la température de l'eau du spa. Demandez à au moins un membre de la famille d'apprendre la réanimation cardiopulmonaire (RCP).

**CELA POURRAIT SAUVER UNE VIE!**

## READ AND FOLLOW ALL INSTRUCTIONS

1. **WARNING** – To reduce the risk of injury, do not permit children to use this product unless they are closely supervised at all times. The appliance can be used by children aged 8 years and above and persons with reduced physical, sensory or mental capabilities or lack of experience and knowledge if they have been given supervision or instruction concerning use of the appliance in a safe way and understand the hazards involved. Children shall not play with the appliance. Cleaning and user maintenance shall not be made by children without supervision.
2. A wire connector is provided on this unit to connect a minimum 8 AWG (8.4 mm) solid copper conductor between this unit and any metal equipment, metal enclosures of electrical equipment, metal water pipe, or conduit within 5 feet (1.5 m) of the unit.

### 3. For cord connected/convertible units:

#### **DANGER – Risk of Injury**

- a) Replace damaged cord immediately.
  - b) Do not bury cord.
  - c) Connect to a grounded, grounding type receptacle only.
4. **DANGER – Risk of Accidental Drowning** – Extreme caution must be exercised to prevent unauthorized access by children. To avoid accidents, ensure that children cannot use this spa unless they are supervised at all times.
  5. **DANGER – Risk of Injury** - The suction fittings in this area are sized to match the specific water flow created by the pump. Should the need arise to replace the suction fittings or the pump, be sure the flow rates are compatible.

Never operate spa if the suction fittings are broken or missing. Never replace a suction fitting with one rated less than the flow rate marked on the original suction fitting.

6. **DANGER – Risk of Electrical Shock – Warning: Before obtaining access to terminals, all supply circuits must be disconnected.** Install at least 5 feet (1.5 m) from all metal surfaces. As an alternative, a spa may be within 5 feet of metal surfaces if each metal surface is permanently connected by a minimum 8 AWG (8.4 mm) solid copper conductor to the wire connector on the terminal box that is provided for this purpose.
7. **DANGER – Risk of Electric Shock** - Do not permit any electrical appliance such as a light, telephone, radio, or television, within 5 feet (1.5 m) of a spa. Parts containing

live parts, except parts supplied with safety extra-low voltage not exceeding 12 V, must be inaccessible to a person in the bath. Parts incorporating electrical components, except remote control devices, must be located or fixed so that they cannot fall into the bath.

**8. WARNING – To reduce the risk of injury:**

- a) The water in a spa should never exceed 104°F (40°C). Water temperatures between 100°F (38°C) and 104°F (40°C) are considered safe for a healthy adult. Lower water temperatures are recommended for young children and when spa use exceeds 10 minutes.
  - b) Since excessive water temperatures have a high potential for causing fetal damage during the early months of pregnancy, pregnant or possibly pregnant women should limit spa water temperatures to 100°F (38°C).
  - c) Before entering a spa, the user should measure the water temperature with an accurate thermometer since the tolerance of water temperature regulating devices varies.
  - d) The use of alcohol, drugs, or medication before or during spa use may lead to unconsciousness with the possibility of drowning.
  - e) Obese persons and persons with a history of heart disease, low or high blood pressure, circulatory system problems, or diabetes should consult a physician before using a spa.
  - f) Persons using medication should consult a physician before using a spa since some medication may induce drowsiness while other medication may affect heart rate, blood pressure, and circulation.
9. To ensure proper functionality and component longevity, individual Jet Pumps must not be cycled on and off more than one time every minute.

**SAVE THESE INSTRUCTIONS**

## LIRE ET ADHÉRER À TOUTES LES CONSIGNES

1. **MISE EN GARDE** – Pour réduire le risque de blessure, ne pas laisser les enfants utiliser ce produit sans supervision constante. L'appareil peut être utilisé par des enfants âgés de 8 ans et plus et des personnes ayant des capacités physiques, sensorielles ou mentales réduites ou un manque d'expérience et de connaissances s'ils ont reçu une supervision ou des instructions concernant l'utilisation de l'appareil de manière sécuritaire et comprennent les dangers inhérents. Les enfants ne doivent pas jouer avec l'appareil. Le nettoyage et l'entretien des utilisateurs ne doivent pas être effectués par des enfants sans surveillance.
2. Un raccordeur de fils est compris avec cet appareil afin de brancher un conducteur en cuivre massif d'au moins 8 AWG (8,4 mm) entre cet appareil et toute pièce d'équipement en métal, enveloppes métalliques d'équipement électrique, tuyau en métal ou canalisation à 5 pieds (1,5 m) ou moins de l'appareil.

3. Appareils convertibles/à cordon:

### **DANGER – Risque de blessure:**

a) Remplacer sans tarder le cordon endommagé.

b) Ne pas enterrer le cordon.

c) Raccorder à une mise à la terre.

4. **DANGER – Risque de noyade accidentelle** – Faire preuve d'extrême prudence afin d'empêcher l'accès non autorisé aux enfants. Pour éviter tout accident, veiller à ce que les enfants ne puissent utiliser ce spa à moins d'être supervisés en tout temps.
5. **DANGER – Risque de blessure** – La taille des raccords de succion est déterminée en fonction du débit d'eau spécifique de la pompe. Si les raccords de succion ou la pompe doivent être remplacés, veiller à ce que les débits d'eau soient compatibles.

Ne jamais faire fonctionner un spa si les raccords de succion sont endommagés ou manquants. Ne jamais remplacer un raccord de succion par un autre dont le débit d'eau est inférieur à celui indiqué sur le raccord de succion original.

6. **DANGER – Risque d'électrocution – Avertissement: Avant d'accéder aux bornes, tous les circuits d'alimentation doivent être déconnectés.** Installer à au moins 5 pieds (1,5 m) de toutes les surfaces en métal. Le spa peut également se trouver à moins de 5 pieds des surfaces en métal si chaque surface en métal est raccordée en permanence par un conducteur en cuivre massif d'au moins 8 AWG (8,4 mm) au raccordeur de fils du disjoncteur prévu à cette fin.

**7. DANGER – Risque d'électrocution** – Interdire tout appareil électrique tel qu'une lampe, un téléphone, une radio ou un téléviseur, à moins de 5 pieds (1,5 m) du spa. Les pièces contenant des pièces en direct, à l'exception des pièces fournies avec une tension extra-basse de sécurité ne dépassant pas 12 V, doivent être inaccessibles à une personne dans le bain. Les pièces incorporant des composants électriques, à l'exception des dispositifs de télécommande, doivent être situées ou fixées de sorte qu'elles ne puissent pas tomber dans le bain.

**8. MISE EN GARDE – Pour atténuer le risque de blessure:**

a) La température de l'eau du spa ne doit jamais dépasser 40°C (104°F). L'eau dont la température varie entre 38°C (100°F) et 40°C (104°F) est jugée sécuritaire pour un adulte en bonne santé. Pour de jeunes enfants ou un usage d'une durée supérieure à 10 minutes, une température plus basse est conseillée.

b) Étant donné que l'eau très chaude peut causer des dommages au fœtus durant les premiers mois de la grossesse, les femmes enceintes qui utilisent le spa doivent limiter la température à 38°C (100°F).

c) Avant d'entrer dans le spa, l'utilisateur doit vérifier la température de l'eau.

d) La consommation d'alcool, de drogues ou de médicaments avant ou pendant l'utilisation du spa peut causer une perte de conscience entraînant la noyade.

e) Les personnes obèses ainsi que celles qui ont des problèmes cardiaques, une tension artérielle faible ou élevée, des problèmes de circulation sanguine, ou qui souffrent de diabète doivent consulter un médecin avant d'utiliser le spa.

f) Les personnes qui consomment des médicaments doivent consulter un médecin avant d'utiliser le spa, car certains médicaments peuvent favoriser la somnolence, et d'autres peuvent affecter le rythme cardiaque, la tension artérielle et la circulation sanguine.

9. Afin d'assurer le bon fonctionnement et longévité des composants, des pompes à Jet ne doit pas être recyclés et s'éteint plusieurs fois chaque minute.

## **CONSERVER CES CONSIGNES**

## Equipment Assemblies

An equipment assembly shall be additionally provided with the following important safety instructions

1. **WARNING** – Risk of Accidental Drowning. Extreme caution must be exercised to prevent unauthorized access by children to avoid accidents, ensure that children cannot use a spa or hot tub unless they are closely supervised at all times. The appliance can be used by children aged 8 years and above and persons with reduced physical, sensory or mental capabilities or lack of experience and knowledge if they have been given supervision or instruction concerning use of the appliance in a safe way and understand the hazards involved. Children shall not play with the appliance. Cleaning and user maintenance shall not be made by children without supervision.
2. **DANGER** – To reduce the risk of drowning from hair and body entrapment, install a suction fitting(s) with a marked flow rate that equals or exceeds the flow rate marked on the equipment assembly.
3. **DANGER** – To reduce the risk of injury, do not remove the suction fittings. Never operate a spa or hot tub if the suction fittings are broken or missing. Never replace a suction fitting with one rated less than the flow rate marked on the equipment assembly.
4. **WARNING** – Risk of Electric Shock. **Warning: Before obtaining access to terminals, all supply circuits must be disconnected.** Install at least 5 feet (1.5 m) from inside wall of hot tub or spa using nonmetallic plumbing.
5. **WARNING** – Risk of Electric Shock. Do not permit any electric appliance, such as a light, telephone, radio, or television, within 5 feet (1.5 m) of a spa or hot tub. Parts containing live parts, except parts supplied with safety extra-low voltage not exceeding 12 V, must be inaccessible to a person in the bath. Parts incorporating electrical components, except remote control devices, must be located or fixed so that they cannot fall into the bath.
6. **WARNING** – To reduce the risk of injury:
  - a) The water in a spa should never exceed 104°F (40°C). Water temperatures between 100°F (38°C) and 104°F (40°C) are considered safe for a healthy adult. Lower water temperatures are recommended for young children and when spa use exceeds 10 minutes.
  - b) Since excessive water temperatures have a high potential for causing fetal damage during the early months of pregnancy, pregnant or possibly pregnant women should limit spa water temperatures to 100°F (38°C).
  - c) Before entering a spa or hot tub, the user should measure the water temperature since the tolerance of water temperature regulating devices varies.
  - d) The use of alcohol, drugs or medication before or during spa or hot tub use may lead to unconsciousness with the possibility of drowning.

- e) Obese persons and persons with a history of heart disease, low or high blood pressure, circulatory system problems, or diabetes should consult a physician before using a spa.
- f) Persons using medication should consult a physician before using a spa or hot tub since some medication may induce drowsiness while other medication may affect heart rate, blood pressure, and circulation.

**7. For equipment assemblies with a gas heater:**

**WARNING** – Risk of suffocation. This equipment assembly uses a gas heater and is intended for outdoor use only unless proper ventilation can be provided for an indoor installation.

**8. For equipment assemblies with a blower:**

**WARNING** – Install blower no less than 1 foot (305 mm) above the maximum water level to prevent water from contacting electrical equipment.

**Marking for Equipment Assemblies**

 <b>WARNING</b>
<p><b>REDUCE THE RISK OF ELECTROCUTION</b></p> <ol style="list-style-type: none"> <li>1. Install at least 5 feet from water using non-metallic plumbing.</li> <li>2. Do not install under spa skirt or within an enclosure that would restrict ventilation.</li> <li>3. If blower is included, install at least 1 foot above maximum water level.</li> </ol>
<p><b>REDUCE THE RISK OF CHILD DROWNING</b></p> <ol style="list-style-type: none"> <li>1. Supervise children at all times.</li> <li>2. Attach spa cover after each use.</li> <li>3. Install a suction guard with marked flow rate no less than 170 GPM to avoid hair and body entrapment.</li> </ol>
<p><b>REDUCE THE RISK OF OVERHEATING</b></p> <ol style="list-style-type: none"> <li>1. Check with a doctor before use if pregnant, diabetic, in poor health, or under medical care.</li> <li>2. Exit immediately if uncomfortable, dizzy or sleepy. Spa heat can cause hyperthermia and unconsciousness.</li> <li>3. Spa heat in conjunction with alcohol, drugs, or medication can cause unconsciousness.</li> </ol>
<p><b>WHEN PREGNANT</b>, soaking in hot water for long periods can harm your fetus. Measure water temperature before entering.</p> <ol style="list-style-type: none"> <li>1. Do not enter spa if water is hotter than 100°F (38°C).</li> <li>2. Do not stay in spa for longer than 10 minutes.</li> </ol>

**SAVE THESE INSTRUCTIONS**



## MODES D'ASSEMBLAGE

Un mode d'assemblage doit également être fourni et comporter les consignes de sécurité suivantes:

1. **MISE EN GARDE** – Risque de noyade accidentelle. Faire preuve d'extrême prudence afin d'empêcher l'accès non autorisé aux enfants. Pour éviter tout accident, veiller à ce que les enfants ne puissent utiliser ce spa à moins d'être supervisés en tout temps. L'appareil peut être utilisé par des enfants âgés de 8 ans et plus et des personnes ayant des capacités physiques, sensorielles ou mentales réduites ou un manque d'expérience et de connaissances s'ils ont reçu une supervision ou des instructions concernant l'utilisation de l'appareil de manière sécuritaire et comprennent les dangers inhérents. Les enfants ne doivent pas jouer avec l'appareil. Le nettoyage et l'entretien des utilisateurs ne doivent pas être effectués par des enfants sans surveillance.
2. **DANGER** – Pour atténuer le risque de noyade causée par la succion du corps et des cheveux, installer un ou des raccords de succion dont le débit d'eau indiqué est égal ou supérieur à celui qui est indiqué sur l'équipement.
3. **DANGER** – Pour atténuer le risque de blessure, ne pas retirer les raccords de succion. Ne jamais faire fonctionner un spa si les raccords de succion sont endommagés ou manquants. Ne jamais remplacer un raccord de succion par un autre dont le débit d'eau est inférieur à celui indiqué sur l'équipement.
4. **MISE EN GARDE** – Risque d'électrocution. **Avertissement: Avant d'accéder aux bornes, tous les circuits d'alimentation doivent être déconnectés.** Installer au moins 5 pieds (1,5 m) de la paroi intérieure du spa avec de la tuyauterie non métallique.
5. **DANGER** – Risque d'électrocution. Ne pas laisser d'appareil électrique tel qu'une lampe, un téléphone, une radio ou un téléviseur, à moins de 5 pieds (1,5 m) du spa. Les pièces contenant des pièces en direct, à l'exception des pièces fournies avec une tension extra-basse de sécurité ne dépassant pas 12 V, doivent être inaccessibles à une personne dans le bain. Les pièces incorporant des composants électriques, à l'exception des dispositifs de télécommande, doivent être situées ou fixées de sorte qu'elles ne puissent pas tomber dans le bain.
6. **MISE EN GARDE** – Pour atténuer le risque de blessure:
  - a) La température de l'eau du spa ne doit jamais dépasser 40°C (104°F). L'eau dont la température varie entre 38°C (100°F) et 40°C (104°F) est jugée sécuritaire pour un adulte en bonne santé. Pour de jeunes enfants ou un usage d'une durée supérieure à 10 minutes, une température plus basse est conseillée.
  - b) Étant donné que l'eau très chaude peut causer des dommages au fœtus durant les premiers mois de la grossesse. Les femmes enceintes qui utilisent le spa doivent limiter la température à 38°C (100°F).

- c) Avant d'entrer dans le spa, l'utilisateur doit vérifier la température de l'eau.
- d) La consommation d'alcool, de drogues ou de médicaments avant ou pendant l'utilisation du spa peut causer une perte de conscience entraînant la noyade.
- e) Les personnes obèses ainsi que celles qui ont des problèmes cardiaques, une tension artérielle faible ou élevée, des problèmes de circulation sanguine, ou qui souffrent de diabète doivent consulter un médecin avant d'utiliser le spa.
- f) Les personnes qui consomment des médicaments doivent consulter un médecin avant d'utiliser le spa, car certains médicaments peuvent favoriser la somnolence, et d'autres peuvent affecter le rythme cardiaque, la tension artérielle et la circulation sanguine.

## 7. Équipement comportant un chauffe-eau à gaz:

### IMPORTANTES CONSIGNES DE SÉCURITÉ

**MISE EN GARDE** – Risque de suffocation. Cet équipement comporte un chauffe-eau à gaz conçu pour un usage à l'extérieur seulement, à moins qu'une ventilation adéquate soit fournie pour une installation à l'intérieur.

## 8. Équipement comportant une soufflante

**MISE EN GARDE** – Installer une soufflante au moins 305 mm (1 pied) audessus du niveau de l'eau maximum pour empêcher l'eau d'éclabousser l'équipement électrique.

### Étiquette destinée aux modes d'assemblage

 <b>MISE EN GARDE</b>
<p><b>RÉDUIRE LE RISQUE D'ÉLECTROCUTION</b></p> <ol style="list-style-type: none"> <li>1. Installer à 5 pieds et plus de l'eau avec de la tuyauterie non métallique.</li> <li>2. Ne pas installer sous la plinthe du spa ou dans une enceinte qui limite la ventilation.</li> <li>3. Si un soufflante est comprise, installer celle-ci au moins 1 pied audessus du niveau maximum de l'eau.</li> </ol>
<p><b>RÉDUIRE LA RISQUE DE NOYADE D'UN ENFANT</b></p> <ol style="list-style-type: none"> <li>1. Superviser les enfants en tout temps.</li> <li>2. Remettre la couverture du spa en place après chaque utilisation.</li> <li>3. Poser un dispositif de protection contre la succion avec débit d'eau indiqué d'au moins 170</li> </ol>
<p><b>RÉDUIRE LE RISQUE DE SURCHAUFFE</b></p> <ol style="list-style-type: none"> <li>1. Consulter un médecin avant usage si vous êtes enceinte, éprouvez des problèmes de santé ou suivez des traitements médicaux.</li> <li>2. Quitter immédiatement le spa en cas d'inconfort, d'étourdissements ou de somnolence. La chaleur du spa peut causer de l'hyperthermie et la perte de conscience.</li> <li>3. La chaleur du spa jumelée à l'alcool, aux drogues ou aux médicaments peut causer la perte de</li> </ol>
<p><b>DURANT LA GROSSESSE</b>, le trempage prolongé peut nuire au fœtus. Vérifier la température de l'eau avant d'y entrer.</p> <ol style="list-style-type: none"> <li>1. Ne pas pénétrer dans le spa si la température de l'eau est supérieure à 38°C (100°F).</li> <li>2. Ne pas rester dans le spa pendant plus de 10 minutes.</li> </ol>

## CONSERVER CES CONSIGNES

## Audio Component Warnings

Spas equipped with the Audio system should follow these guidelines for safety:

1. **CAUTION** – Risk of Electrical Shock - Do not leave compartment door open.
2. **CAUTION** – Risk of Electrical Shock - Replace components only with identical components.
3. Do not operate the audio controls while inside the spa.
4. **WARNING – Prevent Electrocutation** - Do not connect any auxiliary components (for example cable, additional speakers, headphones, additional audio/video components, etc.) to the system.
5. These units are not provided with an outdoor antennae; when provided, it should be installed in accordance with Article 810 of the National Electrical Code, ANSI/NFPA 70.
6. Do not service this product yourself as opening or removing covers may cause exposure to dangerous voltage or other risk of injury. Refer all servicing to qualified service personnel.
7. When the power supply connections or power supply cord(s) are damaged: if water is entering the audio/video compartment or any electrical equipment compartment area; if the protective shields or barriers are showing signs of deterioration; or if there are signs of other potential damage to the unit, turn off the unit and refer servicing to qualified service personnel.
8. This unit should be subjected to periodic routine maintenance (for example, once every 3 months) to make sure that the unit is operating properly.

**KEEP THESE SAFETY INSTRUCTIONS IN A CONVENIENT AND READILY ACCESSIBLE LOCATION!!**

**MISES EN GARDE SUR LES COMPOSANTES DU SYSTÈME DE SON** Les utilisateurs d'un spa doté d'un système de son doivent suivre ces consignes de sécurité:

1. **ATTENTION** – Risque d'électrocution – Ne pas laisser la porte du compartiment ouverte.
2. **ATTENTION** – Remplacer les composantes du système de son par des composantes identiques.
3. Ne pas utiliser les commandes audio lorsqu'on se trouve à l'intérieur du spa.
4. **MISE EN GARDE – Prévention du risque d'électrocution** – Ne pas raccorder les composantes auxiliaires (p. ex., câble, hautparleur supplémentaire, casque d'écoute, autres composantes audio/vidéo, etc.) au système.
5. Ces appareils ne comportent pas d'antenne extérieure; lorsque celle-ci est fournie, elle doit être installée conformément à l'article 810 du Code national de l'électricité, ANSI/NFPA 70.
6. Ne pas tenter de réparer le produit soi-même en ouvrant ou en retirant les couvercles, car cela peut exposer l'utilisateur à une tension dangereuse ou autre risque de blessure. Confier toute réparation à un technicien compétent.
7. Raccords d'alimentation ou les cordons d'alimentation endommagés: si l'eau pénètre dans le compartiment audio/vidéo ou tout compartiment de l'équipement électrique; si les écrans ou barrières de protection montrent des signes d'usure; ou si l'appareil semble endommagé, fermer l'appareil et appeler un technicien compétent.
8. Cet appareil doit être entretenu périodiquement (p. ex., tous les trois mois) pour s'assurer qu'il fonctionne adéquatement.

**PRIÈRE DE CONSERVER CES CONSIGNES DE SÉCURITÉ DANS UN LIEU PRATIQUE ET FACILE D'ACCÈS!!**

# ELECTRICAL REQUIREMENTS

The following information is provided for guidance alone in connecting the electrical power supply to the new swim spa and exercise pool. ***A qualified, licensed, electrician must perform this work. Failure to follow these instructions will terminate all warranty coverage and could result in serious injury or death.***

TidalFit™ Dual Temp FitSpa swim spas and exercise pools are preset at the factory to operate at 240 V, 60 Hz with a 48 A input. This feature provides for the best performance of the swim spa and exercise pool. This will require a 240 V, 60 A Class A GFCI protected service.

## Codes and Compliance

North America – 60 Hz			
	6 ft Spa	8 ft Spa	Swim Spa and Exercise Pool
<b>Voltage</b>	240 VAC	240 VAC	240 VAC
<b>Maximum Current</b>	37 A	48 A	48 A
<b>Number of Wires</b>	4	4	4
<b>GFCI Rating</b>	50 A	60 A	60 A

Export 50 Hz TidalFit™ Dual Temp FitSpa swim spas and exercise pools are factory preset to operate at 240 V with 3 wires and 30 A maximum input. This product must always be connected to a residual current device (RCD) having a trip current of not more than 30 mA.

**Note: Two separate power supplies with protected services are required for all TidalFit™ Dual Temp FitSpas.**

## SWIM SPA AND EXERCISE POOL START-UP

Please read each step of the Start-up section prior to performing the step.

### Selecting a Location

#### General Guidelines

In preparation for installing the new TidalFit™ Dual Temp FitSpa™ swim spa and exercise pool, ensure that the following general guidelines are considered:

**TidalFit™ (May Manufacturing, LLC) highly recommends consulting a qualified licensed contractor, engineer and/or architect prior to the installation of any**

**spa to assure safety, compliance with national, state and local building, electrical and plumbing codes and to account for local geotechnical and environmental conditions. For further assistance, please contact your authorized TidalFit™ Dealer.**

1. Place the swim spa and exercise pool on a structurally sound and level foundation that is large enough for the entire spa. Allow additional space for easy access to equipment compartments and circuit breakers. The location must allow for electrical connections and components to remain dry and away from external sources of water. An adequate drainage system containing proper drainage away from the spa to deal with overflow water and prevent water from entering the electrical equipment areas is necessary in both semi-inground and above ground installations to prevent damage to electronics and tripping circuit breakers. The foundation and/or floor must be able to bear the weight of the expected load consisting of the filled spa, accessories, and occupants. Please contact your local authorized dealer and/or contractor to get the maximum weight value for the corresponding spa model.
2. If the swim spa and exercise pool is placed on the ground, even for a short period of time, it must be supported by stone blocks that are at least 2 inches (5.1 cm) thick and 12 inches (30.5 cm) square. Temporary blocks must create a level foundation and should be located around the perimeter of the spa/pool near the cross-members. Placing the spa on a solid structurally sound foundation as soon as possible is recommended.
3. The swim spa and exercise pool must be installed on a solid, level foundation consisting of a concrete pad (preferred), compacted level ground or a reinforced deck. Concrete foundations must be a minimum 6 inch (15 cm) cement slab that has properly cured for at least 72 hours (this duration may vary due to local conditions and cement properties) and should be reinforced with rebar or mesh. Rebar or mesh reinforcement in the pad should be attached to a #10 AWG bonding wire per national electrical codes. Contact your local building department and/or electrical code compliance inspector for more information and to determine whether an inspection for proper foundation and grounding is required before pouring the concrete slab. **The swim spa and exercise pool warranty will be voided if an improper installation is performed. Structural damage due to an inadequate or improper foundation is not covered under warranty.**
4. Ensure ample space is provided for any required servicing, that equipment access panels are not blocked and easy access to electrical panels or Ground Fault Circuit Interrupters (GFCI) is available. Installation of all swim spas and exercise pools must be in accordance with national, state and local electrical codes and rules. **A licensed Electrician must perform the electrical**

installation of models without a preinstalled cord and conduct a GFCI test procedure in accordance with applicable codes and approved building plans if required. Fixed wiring requires a disconnect device to be incorporated into the wiring in accordance with national, state and local electrical codes and rules. When permitted by applicable codes and rules, a GFCI or Residual-Current Device (RCD) sub-panel may be used in place of a disconnect device. All TidalFit™ Dual Temp FitSpa swim spas and exercise pools are manufactured and tested to all required codes and standards providing maximum protection against electrical shock. **Swim spa and exercise pool safety features may not operate properly due to improper wiring and could result in risk of fire, electrical shock, injury, or death. In accordance with all pertinent national, state and local codes and rules, all metal components within the maximum specified distance must be bonded and connected to the ground lug on the exterior of the swim spa and exercise pool control pack.**

5. Ensure the equipment compartment is in a location where it will not be damaged by water infiltration due to drainage or constant exposure. Cover the equipment compartment with a heavy screen if rodents are a problem. **Damage due to rodents is not covered under warranty.**

## **Outdoor Swim Spa and Exercise Pool Installation Guidelines**

**WARNING:** To prevent serious damage to the spa, support surfaces, support structures and/or injury, it is important that the spa foundation be supported by a stable and consistent subsurface.

**Swim spa and exercise pool placement must take into consideration national, state and local building, electrical, plumbing and safety codes, as well as local environmental and geotechnical conditions. Proof of code compliance for the proposed design plans by a qualified licensed contractor, engineer and/or architect prior to installation may be required for issuance of construction permits. The swim spa and exercise pool must be positioned at the minimum horizontal and vertical distances from all overhead power lines as required by national, state and local codes.** Further factors to consider are the desired proximity to the home, environmental exposures such as wind and sun (ultraviolet radiation), location of trees and other vegetation (falling leaves, grass and dirt tracked into swim spa and exercise pool, roots, shade, etc.), dressing area, landscaping design, lighting, etc. when selecting a location

Since ambient humidity will rise around the swim spa and exercise pool, materials and components in the surrounding area must be able to withstand elevated humidity levels.

Some chemicals for use in sanitation of the swim spa and exercise pool may corrode metals or degrade other materials in the surrounding area. To avoid potential water damage to the cabinet and frame, the swim spa and exercise pool must be located on a site away from automatic sprinklers, drains, gutters, etc. and/or sources of frequent external water exposure.

**For installations on a deck or elevated surface, the maximum filled weight of the swim spa and exercise pool and occupants must be determined. The adequacy of the structural support for a swim spa and exercise pool placed on a deck or an elevated structure must be determined by a licensed structural engineer, architect or contractor depending on local and state requirements. Inadequate structural support may result in structural damage to the swim spa and exercise pool and/or serious injury or death to occupants. Have the swim spa and exercise pool deck installed by a knowledgeable contractor to ensure proper support.**

### **Indoor Swim Spa and Exercise Pool Installation Guidelines**

Swim spa and exercise pool placement must take into consideration national, state and local building, electrical and plumbing codes, local geotechnical conditions affecting the structure of the building, indoor environmental conditions, etc. The surrounding floor surface must have sufficient traction to prevent slips and falls when wet. It is recommended that a floor drain and/or catch basin is present to remove water that accumulates in the area with a capacity up to the total volume of the swim spa and exercise pool model. Since ambient humidity will rise due to the swim spa and exercise pool, ample ventilation is required to prevent mold, mildew, rot, fungus, bacteria and other conditions related to high humidity. Materials and components in the surrounding area must be able to withstand elevated humidity levels. Some chemicals for use in sanitation of the swim spa and exercise pool may corrode metals, or degrade other materials in the surrounding area. A ventilation design incorporating suction, fresh air intake, cross ventilation and/or dehumidifiers may be required and should be determined by an appropriately licensed professional. Ensure ample room is provided for any required servicing and that equipment access panels are not blocked. **Strong foundational support is vital, particularly if a second story site is selected. The adequacy of the structural support for a swim spa and exercise pool placed on a floor above ground level or an elevated surface must be determined by a licensed structural engineer, architect or contractor depending on local and state requirements. Have the swim spa and exercise pool deck installed by a knowledgeable contractor to ensure proper support.**

### **Electrical Wiring**

**WARNING:** The swim spa and exercise pool must be wired by a certified electrician in accordance with local codes and regulations, as well as with these



**instructions. Failure to do so will terminate all warranties and invalidate the independent certification company's mark.**

1. The TidalFit™ Dual Temp FitSpa™ swim spa and exercise pool requires a 240 VAC dedicated system. The swim spa and exercise pool must be hard wired to the power supply, with no plug-in connections, extension cords, or sharing of service. For stationary appliances not fitted with means for disconnection from the electrical supply mains having a contact separation in all poles that provide full disconnection under Overvoltage Category III, the disconnection must be incorporated in the fixed wiring of all supply circuits in accordance with the applicable wiring rules.
2. The swim spa and exercise pool requires 6 (10 mm<sup>2</sup>) or 8 (8.4 mm<sup>2</sup>) AWG copper wire is used, depending on the GFCI size. **Do Not Use Aluminum Wire.**
3. The power supply must have a suitable Ground Fault Circuit Interrupter (GFCI), according to Section 422-20 of the National Electrical Code, ANSI/NFPA 70-7987 or other national installation requirement with a residual current device (RCD) having a trip current of not more than 30 mA. This could be used as the shut-off switch, which must be installed in plain view of the swim spa and exercise pool. This electrical service must be readily accessible to the swim spa and exercise pool occupants, but must not be within 5 feet of the swim spa and exercise pool.
4. Use only non-metallic conduit and fittings when installing power to the swim spa and exercise pool.
5. After the swim spa and exercise pool has been positioned, route lines through the knockout on the left or right front corner of the swim spa and exercise pool.
6. Connect the power to the swim spa and exercise pool – Connect each color to its respective terminal block location. The Ground (green) wire must be connected to the grounding terminal which is outside of the system box. The Grounding wire must first enter the system box and then access the grounding terminal via a hole on the side of the box, adjacent to the grounding terminal as shown in the picture below.

# 60 Hz, 240 V Residential GFCI Wiring Schematic

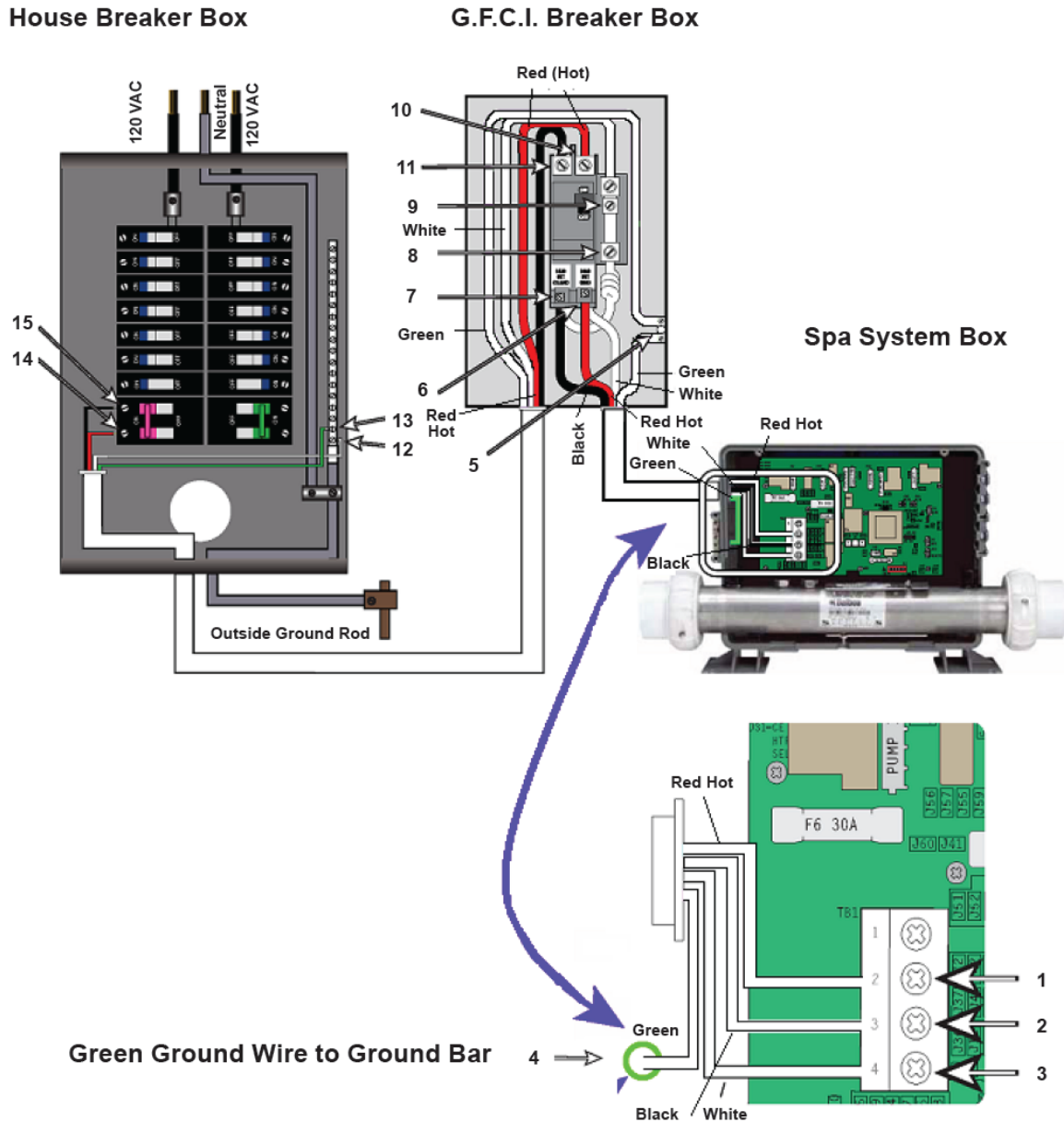

Figure 1. GFCI Wiring Schematic for 60 Hz Systems

**DO NOT CONNECT A COMMON LINE TO A POWER LINE IN THE TERMINAL! THIS WILL DAMAGE THE UNIT.**

**IMPORTANT: A SIEMENS 60 A GFCI CIRCUIT BREAKER IS REQUIRED TO OPERATE THE VARIABLE SPEED TIDALFIT™ DUAL TEMP FITSPAS.**

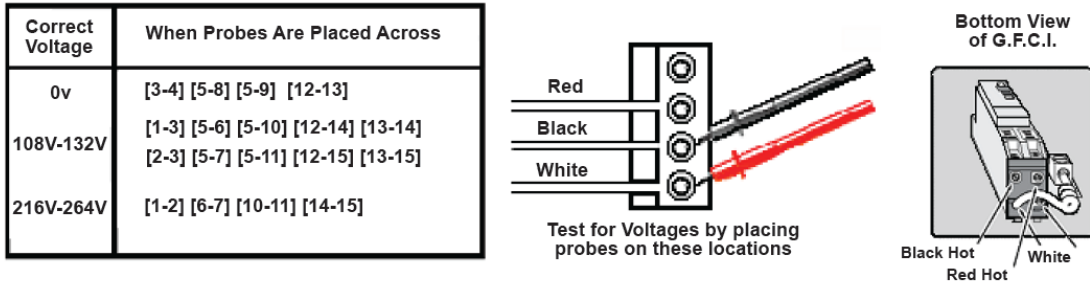

Figure 2. Proper Voltage Readings Across Terminals on House Breaker Box, Swim Spa and Exercise Pool System Box and GFCI

### 50 Hz, 240 V Residential 2 Pole RCD Wiring Schematic

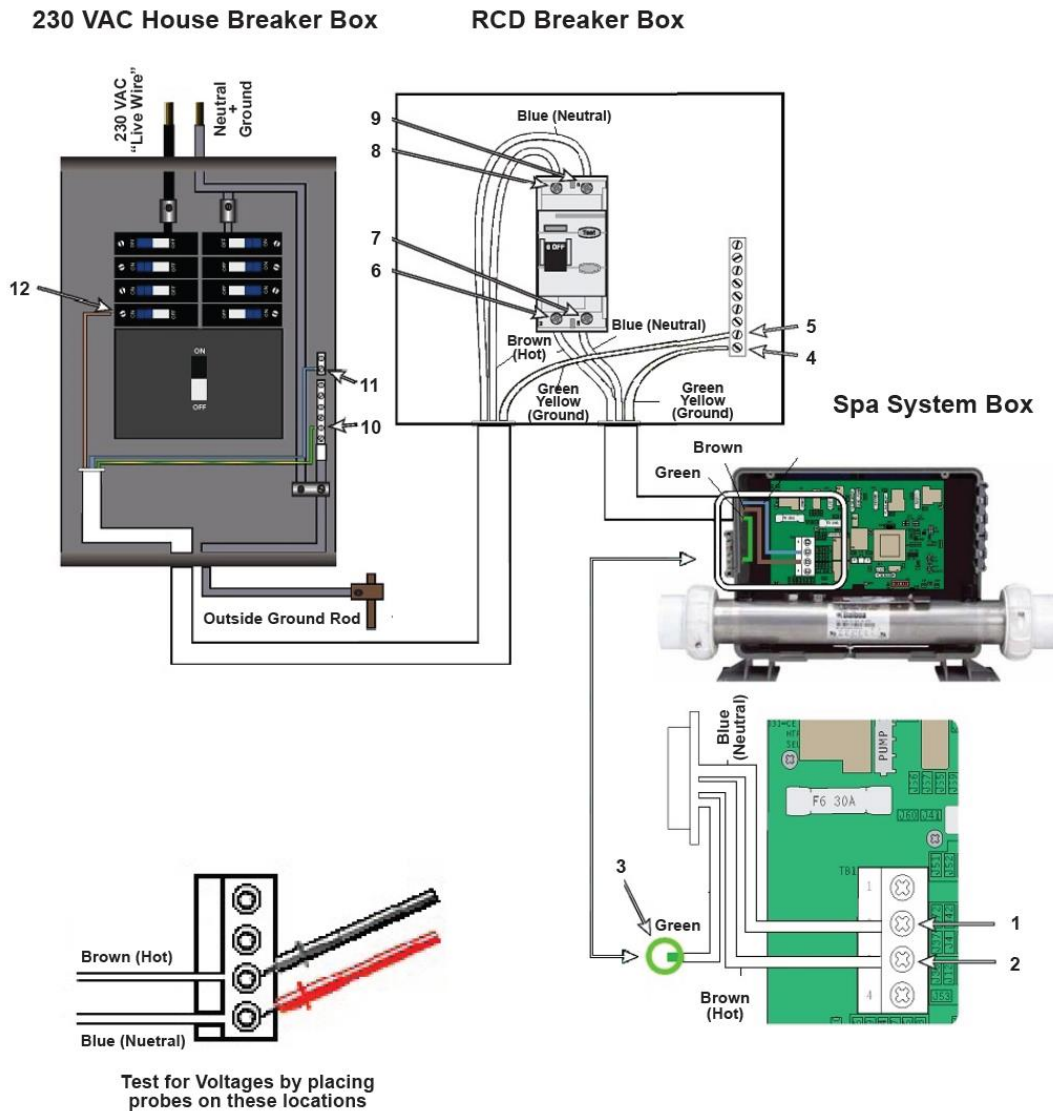

Figure 3. Wiring Schematic for 50 Hz Systems

# 50 Hz Single, Two and Three Phase Power Wiring

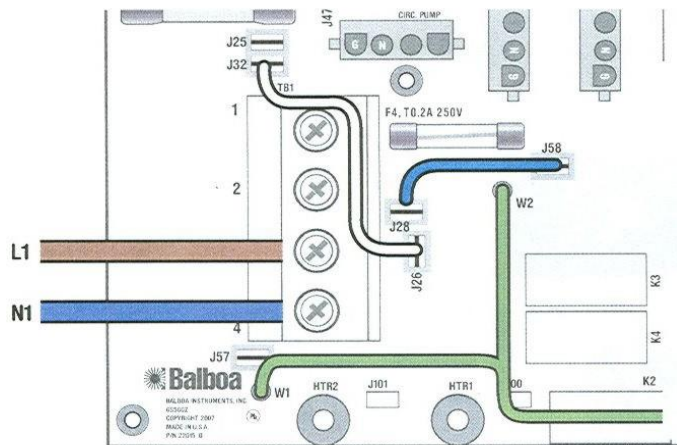

Figure 4. Single Phase Power – TN and TT Electrical Systems

1 X 16 A or 1 X 32 A, 3 Wires (1 Line + 1 Neutral + 1 Protective Earth (Ground))

The protective earth (ground) wire (green–yellow) must be connected to system ground terminal as marked for single phase service. This option is configured and shipped as the default. All equipment (pumps and heater) runs on service line L1.

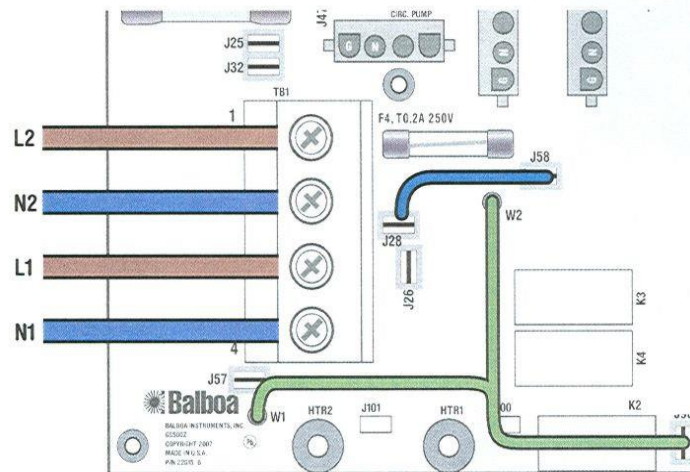

Figure 5. Two Phase Power – TN and TT Electrical Systems

2 x 16 A, 5 Wires (2 Lines + 2 Neutrals + 1 Protective Earth)

The protective earth (ground) wire (green–yellow) must be connected to system ground terminal as marked for dual phase service. The heater runs on service line L1, while all other equipment, such as pumps run on service line L2. Completely remove the white wire from J26 and J32. Please note, J32 and J25

are electrically identical. The white wire may be attached to either terminal before removal.

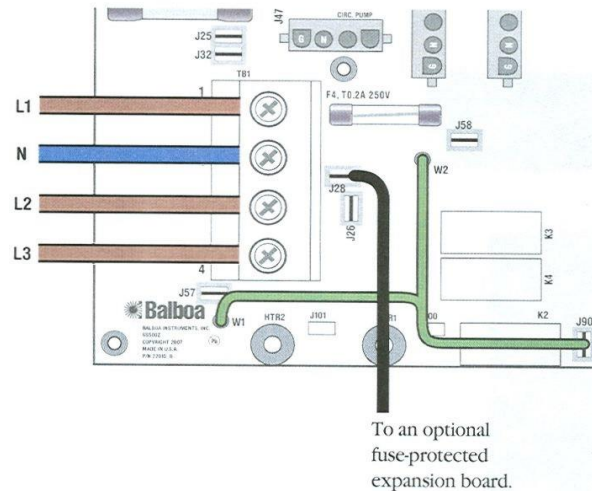

Figure 6. Three Phase Power – TN and TT Electrical Systems  
3 x 16 A, 5 Wires (3 Lines + 1 Neutral + 1 Protective Earth)

The protective earth (ground) wire (green–yellow) must be connected to system ground terminal as marked for dual phase service.

**IMPORTANT – Service MUST include a neutral wire, with a line to neutral (L-N) voltage of 230 VAC.**

The heater runs on service line L1. All main-board equipment runs on service line L3. Additional equipment, such as expansion boards, run on service line L2. Completely remove the white wire from J26 and J32, or J25 on the control pack board. Completely remove the blue wire from J28 and J58 on the control pack board. If an expansion board is installed, the black wire must connect to J28 (Line L2) only.

## TidalFit™ Dual Temp FitSpa™ Semi-Inground Swim Spa and Exercise Pool Installation

The depth of the excavation will vary based upon the on the terrain or slope and model. Consultation a qualified licensed contractor, engineer and/or architect prior to the installation to assure safety, compliance with national, state and local building, electrical and plumbing codes and to account for local geotechnical and environmental conditions is highly recommended as the instructions, dimensions and materials provided are the bare minimum for a general install with ideal conditions. Please refer to the appropriate model's architectural drawings for dimensions and component locations.

Place one bag of ice in each corner and one in the middle of each long side. This will allow you to remove the straps once the spa is in position.



Figure 7. Ice Bag Positioning in Excavation

Crane the spa into position like a normal spa delivery.



Figure 8. Swim Spa And Exercise Pool Position in Excavation on Ice Bag

Allow the ice to melt and then the excavation will be ready for back fill with gravel.

In a flat application, use gravel NOT dirt. When using dirt in other applications, compaction is required to reduce the occurrence of uneven forces on the swim spa and exercise pool. Gravel provides about 98% compaction just by filling in the void space (over dig). The concrete for the deck may now be poured. If a wooden deck is being built there is no real need to backfill except to keep the ground around the swim spa or exercise pool from eroding.

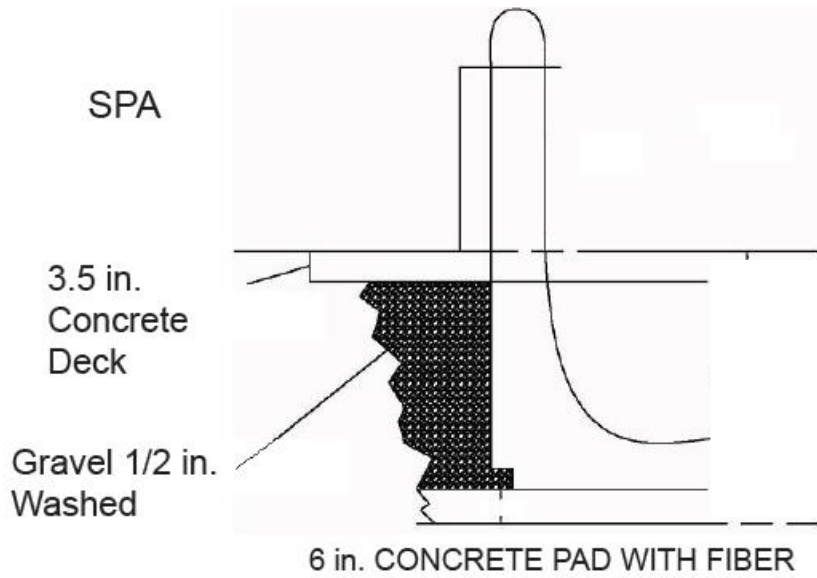

Figure 9. Excavation Cross Section

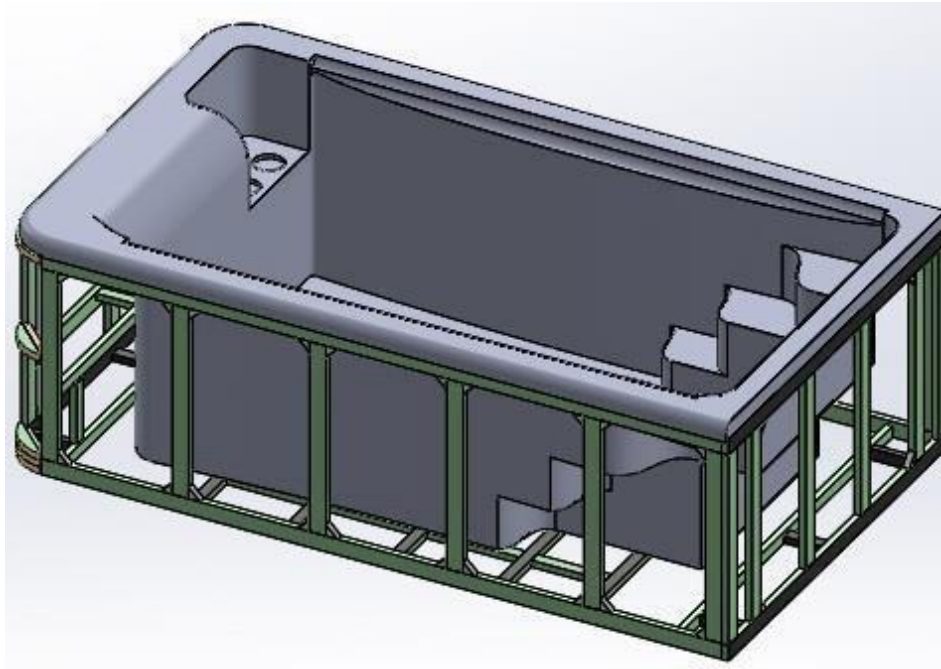

Figure 10. Swim Spa and Exercise Pool Side

Place swim spa and exercise pool side onto a level 6 inch concrete pad with wire mesh (see Selecting a Location - General Guidelines) as shown in Figure 10. Swim Spa and Exercise Pool Side.



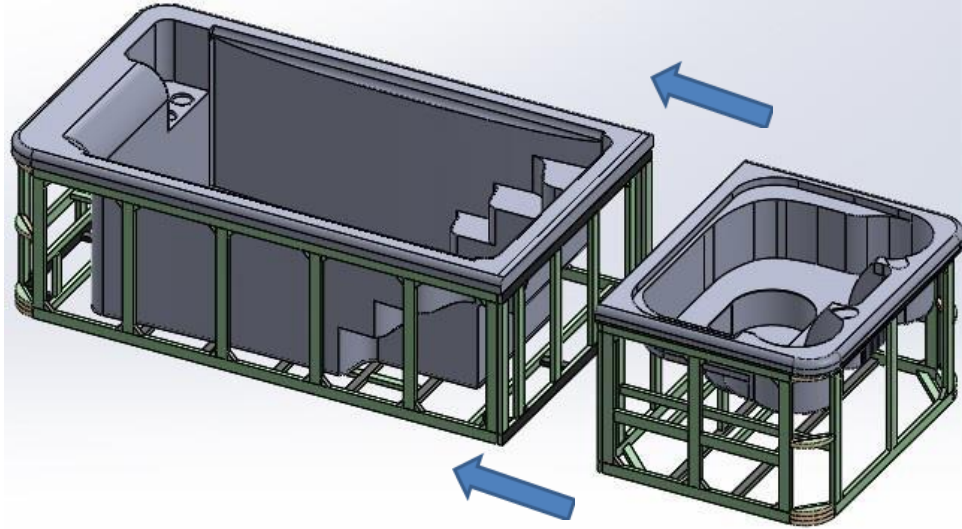

Figure 11. Swim Spa and Exercise Pool Side and Hydrotherapy Spa Positioning

Move the hydrotherapy spa side tightly up against the swim spa and exercise pool side, ensuring that both spas are aligned and shim until flush as shown in Figure 11 and Figure 12.

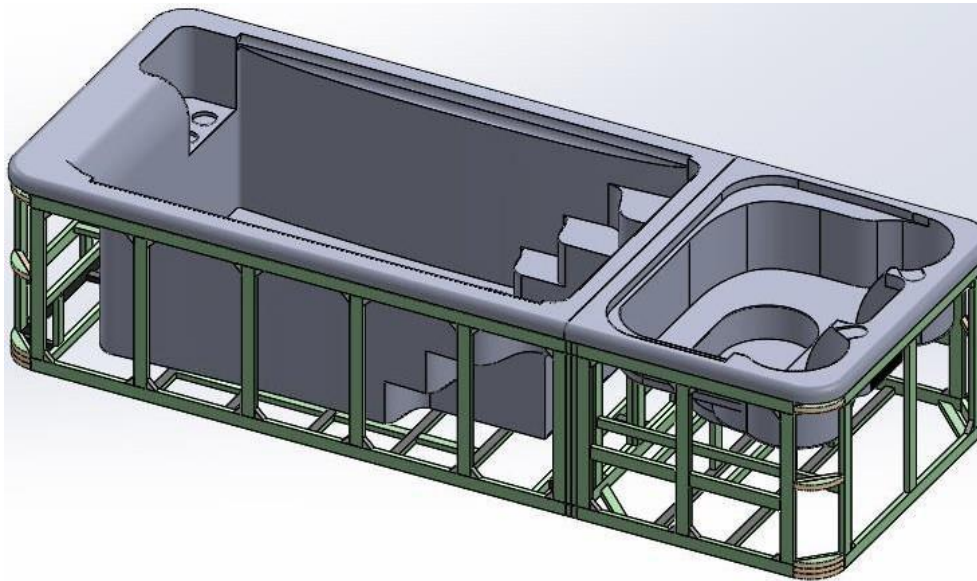

Figure 12. Swim Spa and Exercise Pool Side and Hydrotherapy Spa Position for Attachment

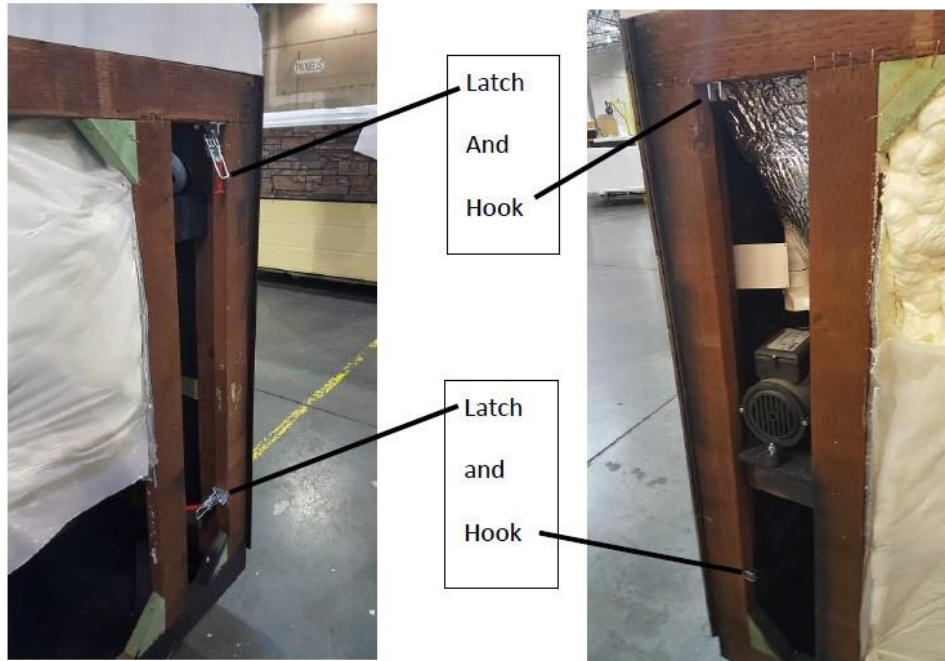

Figure 13. Latch Location on Hydrotherapy and Swim and Exercise Pool Frames

Latches are located on the hydrotherapy spa side while the hook is on the swim spa and exercise pool side as shown in Figure 13.

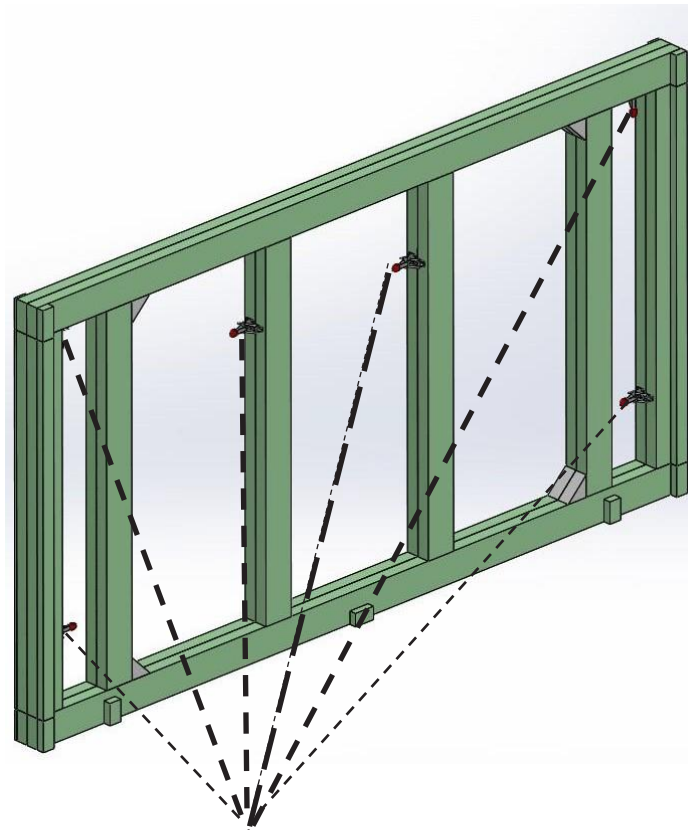

Figure 14. Latch Action Toggle Clamp Locations



Figure 15. Middle Latch Location on Hydrotherapy and Swim and Exercise Pool Frames

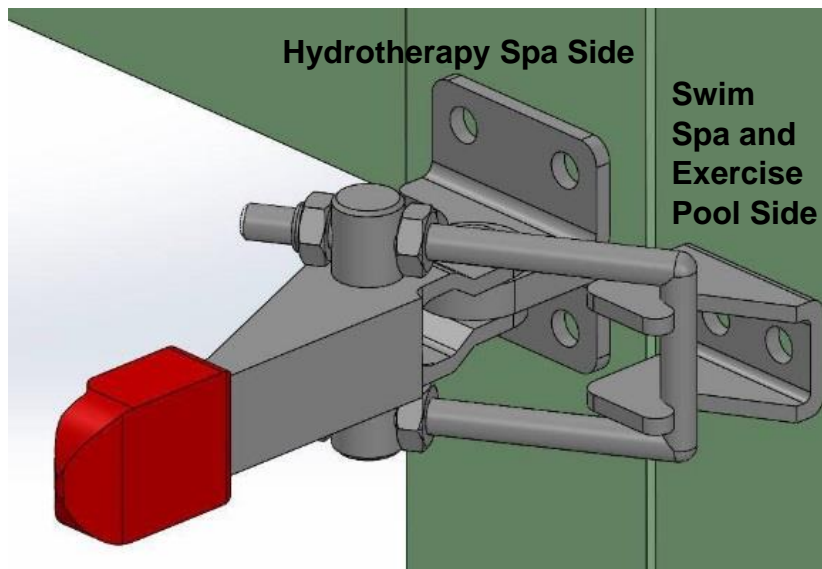

Figure 16. Toggle Latch and Hook Fastener

A close-up view of the proper locking position to ensure maximum tightness is shown in Figure 16.

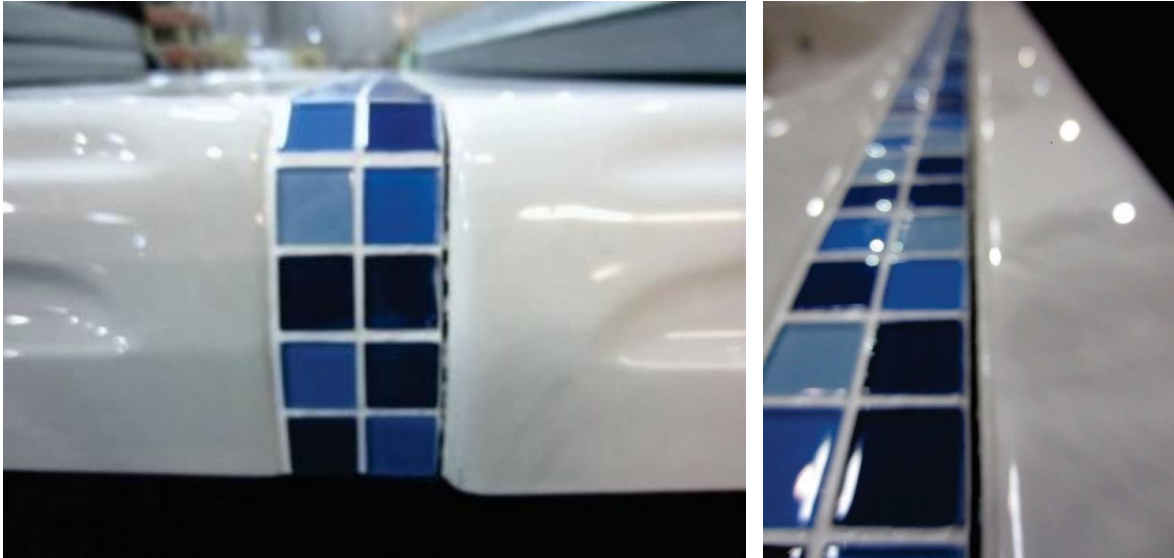

Figure 17. Hydrotherapy and Swim Spa and Exercise Pool Top Edge and Tile Alignment

Apply caulk at ends of tile to seal both the hydrotherapy spa and swim spa exercise pool sides as shown in Figure 17. Tile is pre-installed on the spa and caulk is only needed for the pool side.

### **Filling the Dual Temp FitSpa with Water**

Perform an inspection of the entire swim spa and exercise pool prior to filling it with water. Look for and remove any debris in the swim spa and exercise pool and/or in the filter area. Verify that pump plugs are installed on the pumps and all pump unions are tight.

**DO NOT fill the swim spa and exercise pool with hot water straight out of a water heater or tap. This water may be in excess of 140°F (60°C) and will cause damage to the surface and plumbing of the swim spa and exercise pool and may cause severe burns to individuals. Filling the swim spa and exercise pool with hot water will void the warranty. Ensure the swim spa and exercise pool is level before filling.**

1. Prepare to fill the tub by removing all debris.
2. Remove the filters from the swim spa and exercise pool (see Removing, Installing and Cleaning Filters, page 67).
3. Insert the hose in the area where the filter was located as shown in the picture below.



Figure 18. Filling Location in Filter Housing

4. Fill the swim spa and exercise pool to the bottom of the pillows to cover jets. **DO NOT overfill the swim spa and exercise pool.** The water level will rise when occupants are inside.
5. With the front panel off, verify there are no leaks at the pump unions. **Pump unions can become loose during shipping. Verify that there are no leaks during filling of the swim spa and exercise pool.**
6. Replace both filters.

## Powering the Swim Spa and Exercise Pool On

Turn the power to the swim spa and exercise pool on at the main circuit breaker. Verify that the swim spa and exercise pool has no warnings or error messages on the panel display. To verify the circulation system is in good working order, perform the following steps:

1. Open all jets to maximum flow position.
2. Press the Jet 1, 2 and 3 buttons to turn the individual pumps on or off.
3. Observe and verify good water flow exists in the jets of each seat.

Upon initial start, one pump will initially come on for 5 minutes and then cycle through each pump sequentially for a one minute duration.

## Testing the GFCI for a 60 Hz System

The electrical service panel for the swim spa and exercise pool must be equipped with a GFCI. To avoid the risk of electrical shock, perform the following safety test before each use of the swim spa and exercise pool:

1. Check that the power is turned on at the electrical service panel.
2. Turn on the GFCI. If the GFCI stays on, it is functioning properly.

The swim spa and exercise pool system will automatically trip the GFCI 24 hours after power up. This is a safety feature and cannot be disabled.

The installer can cause the GFCI Trip Test to occur by initiating the sequence in **Error! Reference source not found.** on page **Error! Bookmark not defined.**

The GFCI should trip within several seconds and the swim spa and exercise pool should shut down. If it does not, shut down the power and manually verify that a GFCI breaker is installed and that the circuit and swim spa and exercise pool are wired correctly.

Once the GFCI is tripped by the test, reset the GFCI and the swim spa and exercise pool will operate normally thereafter. You can verify a successful test by navigating to the “GFCI Test” page as described in the above steps.

To verify the test restore the power to the pool and repeat the GFCI Trip Test. The GFCI status should change from armed to passed.

### **DANGER RISK OF ELECTRICAL SHOCK**

If the GFCI fails to operate as described, there is a possibility of electric shock if the swim spa and exercise pool is used. Shut off the power at the main electrical service panel until the source of the problem has been identified and corrected by a licensed electrician or qualified swim spa and exercise pool technician.

## Priming Pumps

1. Turn off power at electrical service panel.
2. Locate and loosen the pump union by turning it counterclockwise one half of one turn.
3. Allow air to escape from the fitting. When a steady stream of water flows from the pump union, close it by turning it clockwise until tight.
4. Turn on power at electrical service panel.

5. Perform one additional check to ensure water is flowing from the jets during the auto purge cycle. If so, continue to Water Preparation. If no water flow is coming from the swim spa and exercise pool jets, please call your TidalFit™ dealer for further assistance.

## **Water Preparation**

Proper understanding of the treatment of fresh water prior to use is an important part of maintenance and is one of the key aspects enabling worry free usage. Failure to properly prepare the water can result in substantially decreased life of the components and may void the warranty in severe cases. Please consult your local TidalFit™ dealer in regards to appropriate start-up and maintenance kits available when purchasing the swim spa and exercise pool.

## Rowing and Exercise Equipment Installation and Use

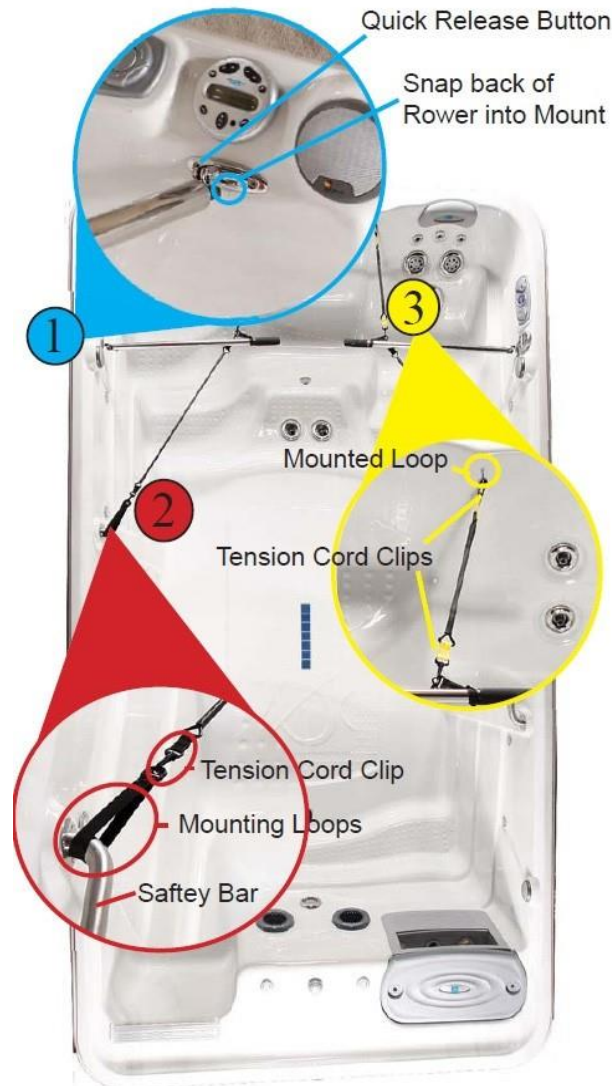

Figure 19. Rowing Equipment and Tension Cord Mount Locations

- 1 Install Rowers**  
Press the quick release button. Snap the back of the rowing bar into the mount.
- 2 Install First Set of Tension Cords**  
Use the mounting loops as a slip knots around each safety bar. Clip tension cord to mounting loop. Clip tension cord to rowing bar.
- 3 Install Second Set of Tension Cords**  
Choose a desired pair of the varying length tension cords. Clip the tension cord to the mounted loop. Clip the tension cord to the row bar.

The tension cords are varying sizes to compensate for different levels of tension.



## Rowing Exercise

Sit in the rowing seat and grasp the rower handles, to begin your rowing exercise.



Double check the Rowers, making sure that each clip, cord and rower is mounted securely.



## Upper Body Workouts

- 1 Install Tension Cords** Choose a desired pair of the varying length tension cords. Clip the tension cords to the mounted loops (see Figure 20). Attach handles to the tension cord.



### Chest Press

Standing upright and facing away from the cords, Position your hands and elbows at your sides, chest level. Keeping your elbows at chest level, push until your arms are outstretched in front of you.

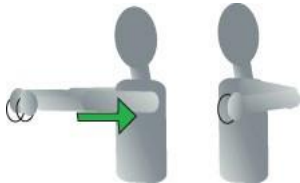

### Shoulder Pull

Stand upright holding the cords in front of you with a little bit of tension. Start with arms and hands at chest level and outstretched in front of you. Pull arms to your sides, keeping your elbows at chest level.



### Back Pull

Stand upright holding the cords in front of you with a little bit of

tension. Start with arms at chest height and outstretched in front of you. Bend your arms, and pull your elbows diagonally to your waist.

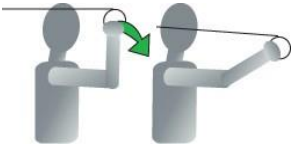

### Triceps Pull

Sitting in the seat and facing away from the cords, position your elbows chest level, and hands eye level. Keeping your elbows parallel to your shoulders, pull until your arms is outstretched in front of you.

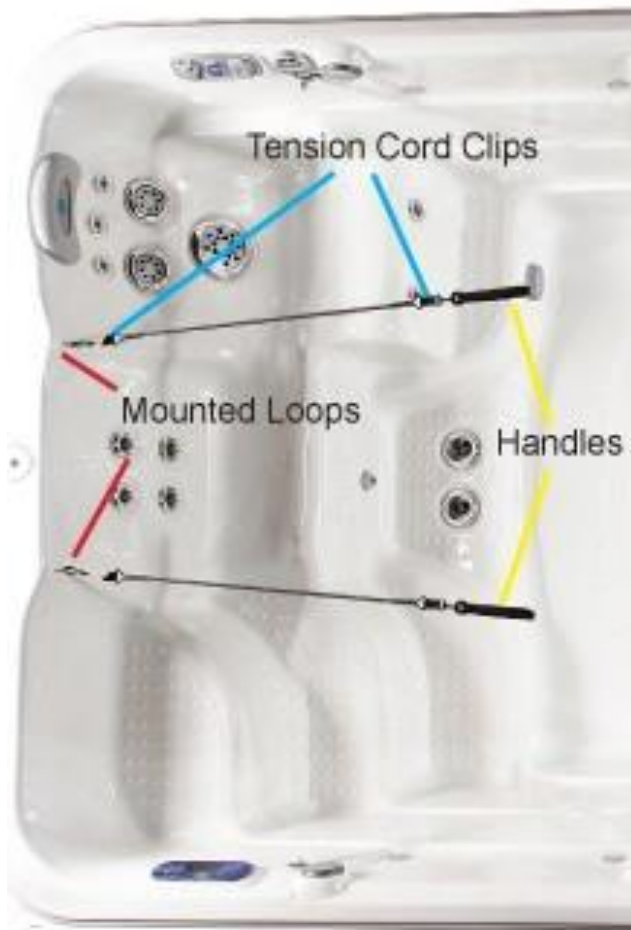

Figure 20. Tension Cord Mount Locations

## Run In Place Treadmill with Super Swim Pole

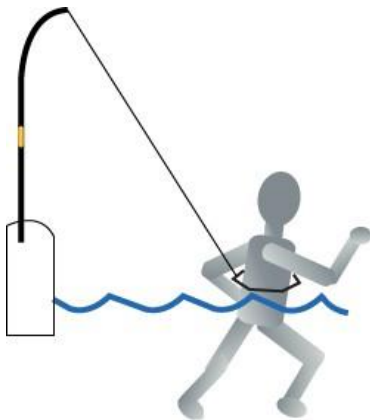

Figure 21. Super Swim Pole Attachment Location

- 1 Install Super Swim Pole**

Attach the two poles together by matching up the brass attachments and twisting until tightened. Place bottom of the pole into the attachment on the lip of the pool, above the rowing seat. Adjust nylon rope to desired length.
- 2 Install Waist Band**

Pull the stainless steel clip along the waist band to adjust belt's diameter. Strap waist belt attachment to your waist by buckling the smaller clip into the larger, angled clip.



Run in Place Treadmill, utilizing Super Swim Pole and water resistance.

## Advanced Swimming with Super Swim Pole

- 1 Install Super Swim Pole**

Attach the two poles together by matching up the brass attachments and twisting until tightened. Place bottom of the pole into the attachment on the lip of the pool, above the rowing seat. Adjust nylon rope to desired length.
- 2 Install Waist Band**

Pull the stainless steel clip along the waist band to adjust belt's diameter. Strap waist belt attachment to your waist by buckling the smaller clip into the larger, angled clip.

### Swimming with Added Resistance

Practice advanced swimming techniques and swim at a faster rate with the waist attachment.

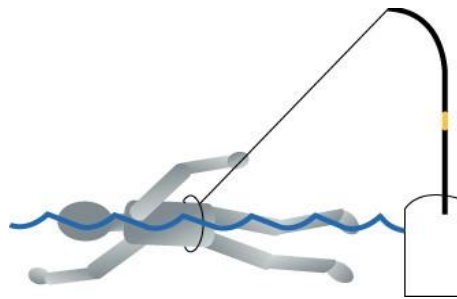

# TOPSIDE CONTROLLER INSTRUCTIONS FOR HYDROTHERAPY AND SWIM AND EXERCISE POOL SIDES

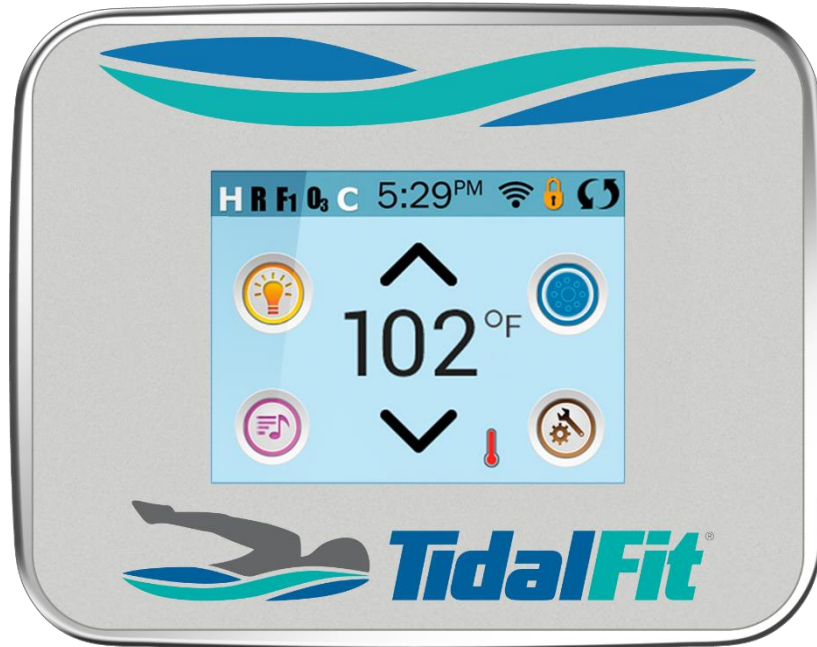

Figure 22. TidalFit™ Dual Temp FitSpa™ Three Pump Topside Controller Face

## Main Screen

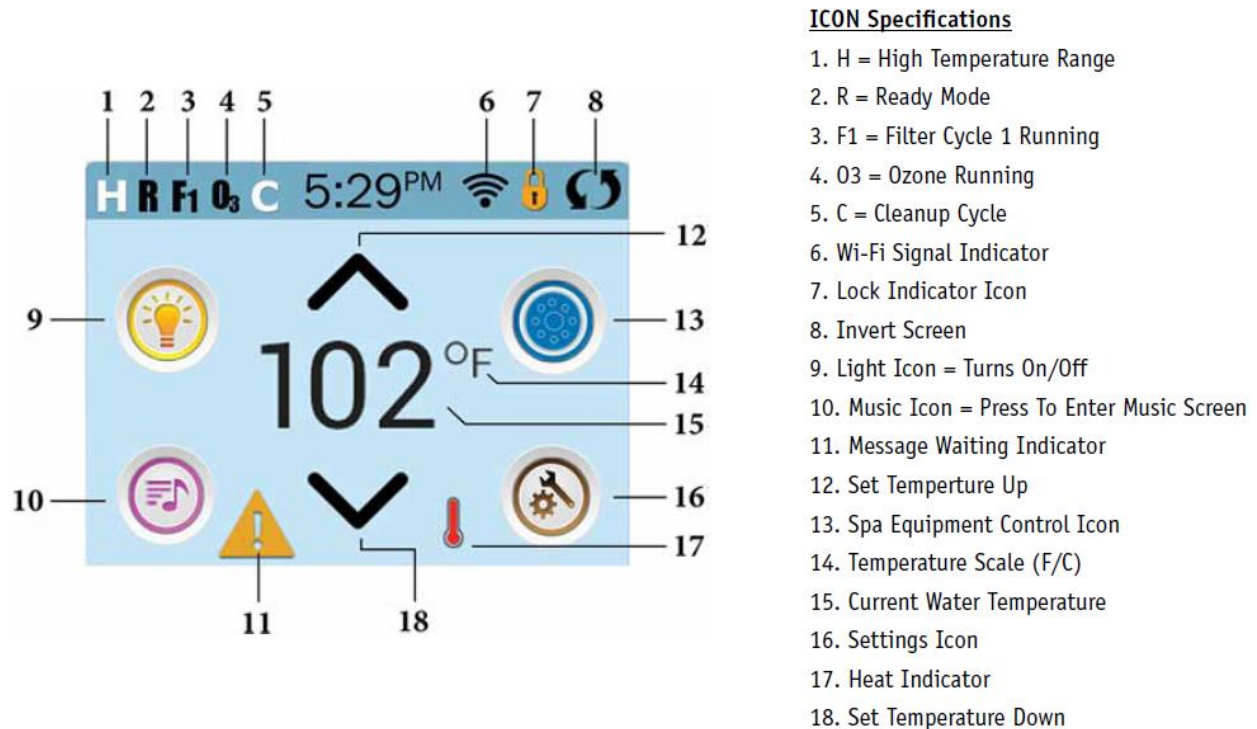

Figure 23. Main Screen Layout

## Spa Status

Important information about spa operation can be seen quickly from the Main Screen. Most features, including Set Temperature adjustment, can be accessed from this screen. The actual water temperature and Set Temperature can be seen, and the Set Temperature can be adjusted (see The Set Temperature Screen). Time-of-Day, Ozone and Filter status is available, along with other messages and alerts. The selected Temperature Range is indicated in the upper right corner. The Jets Icon in the center will spin if any pump is running and changes color when the heater is on. A Lock icon is visible if the panel or settings are locked.

The Menu choices on the right can be selected and the screen will change to show more detailed controls or programming functions.

**To ensure proper functionality and component longevity, individual Jet Pumps must not be cycled on and off more than one time every minute.**

**Note: After 30 minutes the display will automatically go into sleep mode, which turns the display off. This is normal operation. Touch anywhere on the screen to wake the panel up. The actual number of minutes can be customized. See Panel section.**

## ICON Specifications

1. = High Temperature Range. = Low Temperature Range.
2. = Ready Mode. = Ready And Rest Mode. = Rest Mode.
3. = Filter Cycle 1 is running. = Filter Cycle 2 is running. = Filter Cycles 1 and 2 are both running.
4. = Ozone is Running. If you don't see the icon that means the Ozone is OFF.
5. = Cleanup Cycle is Running. Note: Not all systems that can run a Cleanup Cycle display this icon.
6. = Wi-Fi icon just indicates that the Wi-Fi link is connected. It does not indicate signal strength. Note: Not all systems that support Wi-Fi display this icon.

### 7. Lock Icon:

When displayed, indicates the panel is in a locked mode. To unlock or lock a setting or panel lock, first press the corresponding icon on the Lock Screen, then press and hold the word "Lock" for 5+ seconds until the text and icon change to the opposite state.

There are 2 lock icons that can be shown on the title bar of most screens. A tall skinny one representing a settings lock is applied. It is shown on screens that are affected by the settings lock. And the standard lock icon Padlock which represents the Panel being locked. If both settings and panel are locked, only the panel lock will show since the settings lock doesn't do much in that situation. When the panel is locked, the Settings Screen will only show items not affected by that lock (System Info and Lock Screens).

8. = Invert (or flip) Screen.
9. = Lights is turned ON. = Light is Inactive. = Light is Disabled.
10. = Music is Active. = Music is Inactive. = Music is Disabled.

### 11. Message Waiting Indicator:

The Message Waiting Indicator will show one of the following icons:

- = Fatal error (Spa can't function until it's fixed)
- = Normal Error or Warning
- = Reminder Message
- = Information Message.

Touch the Indicator to go to a Message Screen which shows the message.

Some messages will include the "Call for Service" text as it requires a service technician to fix the problem. If the panel is locked and a message alert appears, you will be taken to the Lock Screen (where you will need to Unlock the panel) before you can clear the message.

Touching the Error/Warning/Reminder/Info Icon on the Message Screen will take you to the System Information Screen to allow for troubleshooting over the phone or for a field service tech to better understand what is going on. Exiting the System information Screen will take you back to the Message Screen in that situation.

12. Adjust set temperature higher.
13. = Spa Equipment Control Icon. Brings up a screen where the spa jets, blower or other equipment can be controlled. While on the Spa Equipment Screen, you can press a Jets button once for low speed, and if configured press it again for high speed. = Jet is Inactive. Indicates if a pump is running or not.
14. Indicates if the temperature is in = Fahrenheit or = Celsius.
15. Current water temperature if or is solid; set temperature if or is flashing.
16. Setting Icon. = Settings is Active. = Settings is Inactive (when the panel is locked). Takes you to Settings Screen
17. Different animation sequences, including blinking, may indicate different stages of heating.
18. Adjust set temperature lower.

## Navigation

Navigating the entire menu structure is done by touching the screen. When a text item is shown in white on the main screen, it is selectable. The menu selections on the right side of the screen can be selected. Select one of these to enter a different screen with additional controls.

Most menu screens time out and revert to the main screen after 30 seconds of no activity.



The only item that can be changed on the left side of the Main Screen is the Set Temperature. Touch either the set temperature line or the water temperature to go to the Set Temperature screen. See next page.

## Messages

At the bottom of the screen, messages may appear at various times. Some of these messages must be dismissed by the user (see General Messages).

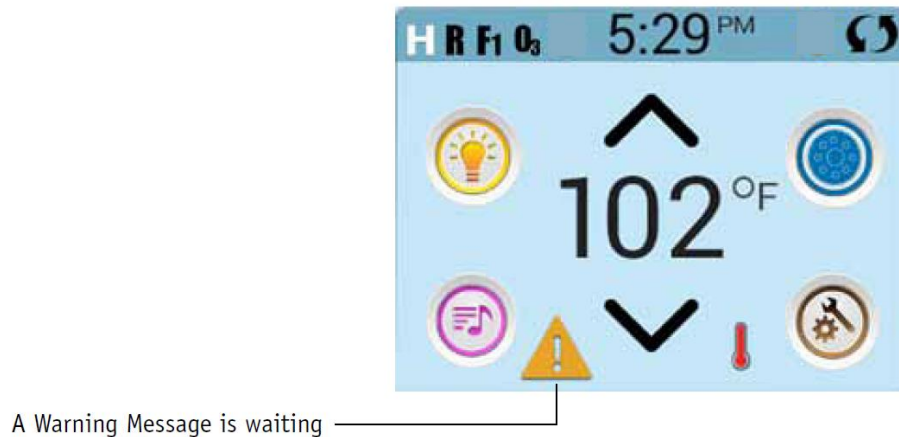



## The Set Temperature Screen

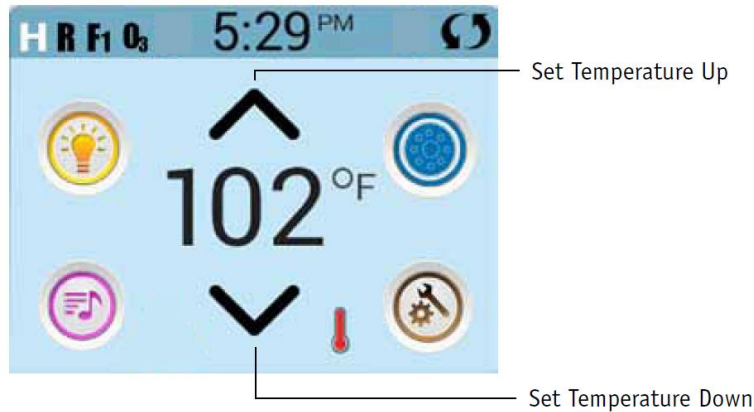

### Set Temperature

Press Inc or Dec to modify the Set Temperature. The Set Temperature changes immediately. Press Back to return to the Main Screen. If you need to switch between high range and low range you need to go to the Settings Screen.

### Press-and-Hold

If the Up or Down button is pressed and held, the temperature will continue to change until the button is released, or the Temperature Range limits are reached.

## The Spa Screen

The Spa Screen shows all available equipment to control, as well as other features, like Invert. The display shows icons that are related to the equipment installed on a particular spa model, so this screen may change depending on the installation. The icon buttons are used to select and control individual devices. Some devices, like pumps, may have more than one ON state, so the icon will change to reflect the state that the equipment is in. Below are some examples of 2-speed Pump indicators.

If the Spa has a Circ Pump, a Circ Pump Icon will appear to indicate its activity, but outside of Priming Mode, the Circ Pump cannot be controlled directly.



NOTE: The icon for the pump that is associated with the heater (Circ or P1 Low) will have a red glow in the center when the heater is running.

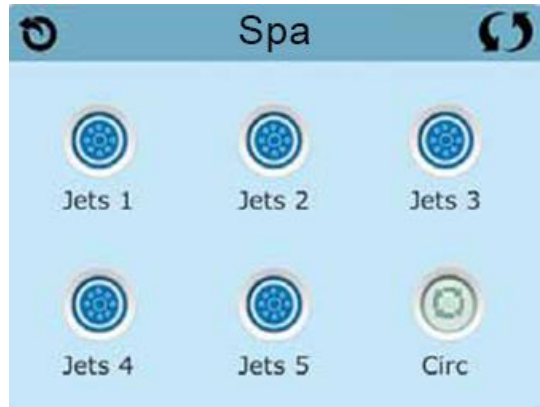

## Common Buttons

### Values Increment / Decrement

If an Up or Down button is shown and pressed when on an editing page, and a value has been selected (highlighted), the value can be incremented by pressing the up arrow or decremented by pressing the down arrow.

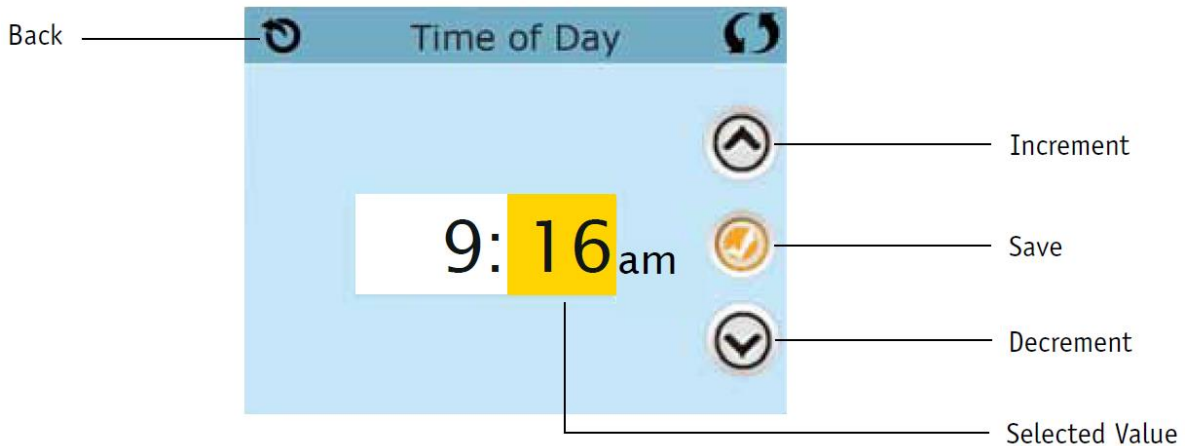

### Invert Panel

Selecting Invert Panel will flip the display and the buttons so the panel can be easily operated from inside or outside the hot tub.



## Exiting Screens

The Back button is on every screen except the Main Screen, the Priming Mode Screen and a Message Display Screen.

When you see only this button, or this button plus an Inactive Save Button, it means Back or Exit. It appears on editing screens before you have changed any value, as well as on all other screens.

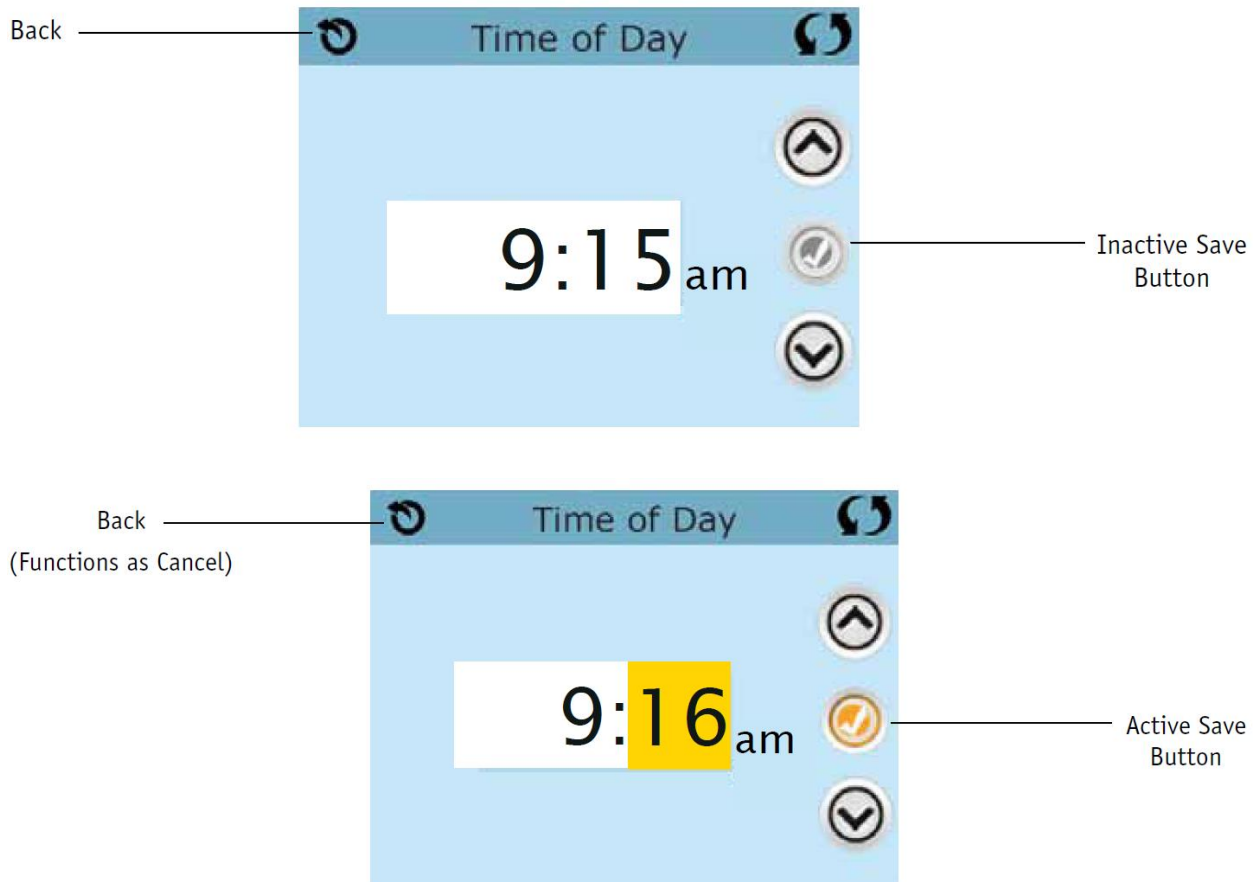

When you see both the Back button and an Active Save button, the Save button will save, while the Back button will Cancel. If the screen times out due to no activity it will act like Cancel.

## Page Right/Left

If there is a right arrow at the bottom of the screen, it takes you to the next page.

If there is a left arrow at the bottom of the screen, it takes you to the previous page.



## Page Up / Down

If an Up or Down button is shown and pressed when in a Menu List, the list can be scrolled a page at a time.

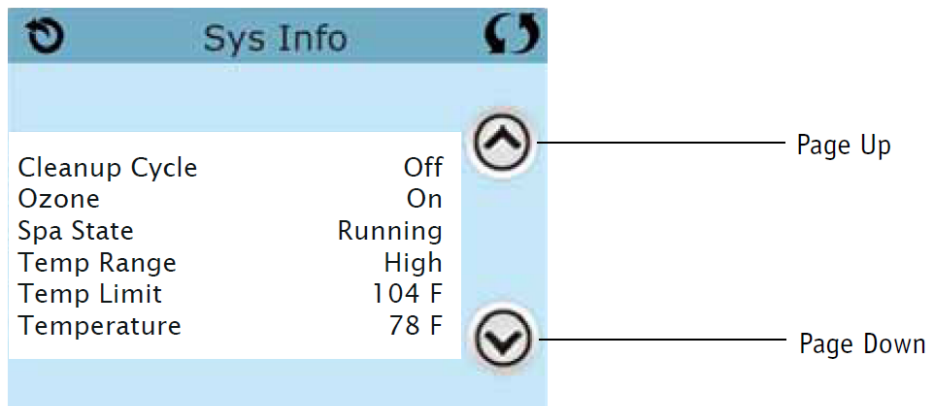

## Programming, Etc.

The Settings Screen is where all programming and other spa behaviors are controlled.

Each icon on the Settings screen takes you to a different screen, where one or more setting may be viewed and/or edited.



The Heat Icon  takes you to a screen where you control the Heat Mode and the Temperature Range.

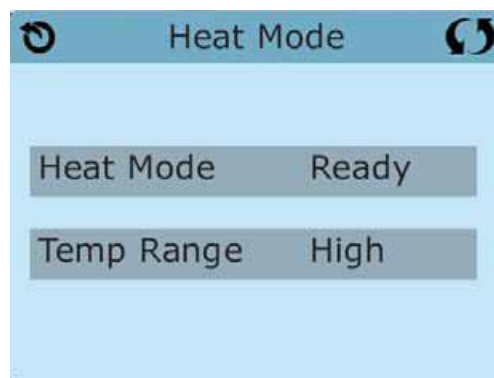

### **Dual Temperature Ranges (High vs. Low)**

This system incorporates two temperature range settings with independent set temperatures. The specific range can be selected on the Settings screen and is visible on the Main Screen in the upper right corner of the display.

These ranges can be used for various reasons, with a common use being a “ready to use” setting vs. a “vacation” setting.

Each range maintains its own set temperature as programmed by the user. This way, when a range is chosen, the spa will heat to the set temperature associated with that range.

High Range can be set between 80 °F and 104 °F.

Low Range can be set between 50 °F and 99 °F.

More specific Temp Ranges may be determined by the Manufacturer.

Freeze Protection is active in either range.

## **Heat Mode – Ready vs. Rest**

In order for the spa to heat, a pump needs to circulate water through the heater. The pump that performs this function is known as the “heater pump.”

The heater pump can be either a 2-speed pump (Pump 1) or a circulation pump.

If the heater pump is a 2-Speed Pump 1, Ready Mode will circulate water every 1/2 hour, using Pump 1 Low, in order to maintain a constant water temperature, heat as needed, and refresh the temperature display. This is known as “polling.”

Rest Mode will only allow heating during programmed filter cycles. Since polling does not occur, the temperature display may not show a current temperature until the heater pump has been running for a minute or two.

When the heater pump has come on automatically (for example for heating) you can switch between low speed and high speed but you cannot turn the heater pump off.

## **Circulation Mode (See Pumps, for other circulation modes)**

If the spa is configured for 24HR circulation, the heater pump generally runs continuously. Since the heater pump is always running, the spa will maintain set temperature and heat as needed in Ready Mode, without polling.

In Rest Mode, the spa will only heat to set temperature during programmed filter times, even though the water is being filtered constantly when in 24HR circulation mode.

## **Ready-in-Rest Mode**

Ready in Rest Mode appears in the display if the spa is in Rest Mode and the Jets 1 Button is pressed. When the heater pump has come on automatically (for example for heating) you can switch between low speed and high speed but you cannot turn the heater pump off. After 1 hour, the System will revert to Rest Mode. This mode can also be reset by entering the Settings Menu and selecting the Heat Mode line.

\* M0XX is a Message Code. Codes like this will be seen in the Fault Log.

## **Priming Mode – M019\***

After the initial start-up sequence, the control will enter Priming Mode and display a Priming Mode screen. Only pump icons appear on the priming mode screen. During the priming mode, the heater is disabled to allow the priming process to be completed without the possibility of energizing the heater under low-flow or no-flow conditions. Nothing comes on automatically, but the pump(s) can be energized by selecting the “Jet” buttons. If the spa has a Circ Pump, it can be turned on and off by pressing the “Circ Pump” button during Priming Mode.

## Priming the Pumps

As soon as the Priming Mode screen appears on the panel, select the “Jets 1” button once to start Pump 1 in low-speed and then again to switch to high-speed. Also, select the other pumps, to turn them on. The pumps should be running in high-speed to facilitate priming. If the pumps have not primed after 2 minutes, and water is not flowing from the jets in the spa, do not allow the pumps to continue to run. Turn off the pumps and repeat the process. Note: Turning the power off and back on again will initiate a new pump priming session. Sometimes momentarily turning the pump off and on will help it to prime. Do not do this more than 5 times. If the pump(s) will not prime, shut off the power to the spa and call for service.

Important: A pump should not be allowed to run without priming for more than 2 minutes. Under NO circumstances should a pump be allowed to run without priming beyond the end of the 4-5 minute priming mode. Doing so may cause damage to the pump and cause the system to energize the heater and go into an overheat condition.

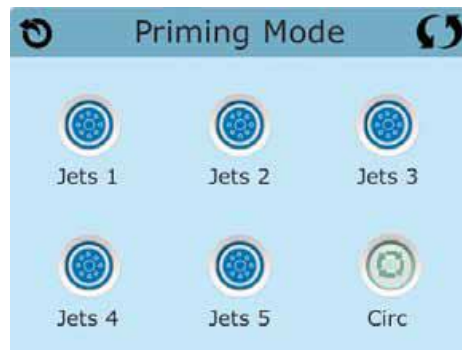

## Exiting Priming Mode

The system will automatically enter the normal heating and filtering at the end of the priming mode, which lasts 4-5 minutes.

You can manually exit Priming Mode by pressing the “Exit” button on the Priming Mode Screen. Note that if you do not manually exit the priming mode as described above, the priming mode will be automatically terminated after 4-5 minutes. Be sure that the pump(s) have been primed by this time.

Once the system has exited Priming Mode, the top-side panel will display the Main Screen, but the display will not show the temperature yet, as shown below. This is because the system requires approximately 1 minute of water flowing through the heater to determine the water temperature and display it.

---°F ---°C

## **Pumps**

On the Spa Screen, select a “Jets” button once to turn the pump on or off, and to shift between low and high-speeds if equipped. If left running, the pump will turn off after a time-out period.

### **Non-Circ Systems**

The low-speed of pump 1 runs when the blower or any other pump is on. If the spa is in Ready Mode (see page 47), Pump 1 low may also activate for at least 1 minute every 30 minutes to detect the spa temperature (polling) and then to heat to the set temperature if needed. When the low-speed turns on automatically, it cannot be deactivated from the panel, however the high speed may be started.

### **Circulation Pump Modes**

If the system is equipped with a circ pump, the programmable circ pump will come on when the system is checking temperature (polling), during filter cycles, during freeze conditions, or when another pump is on.

### **Filtration and Ozone**

On non-circ systems, Pump 1 low and the ozone generator will run during filtration. On circ systems, the ozone will generally run with the circ pump, but can be limited to filtration cycles. (On some circ systems, Pump 1 low will run along with the circ Pump during filtration.)

The system is factory-programmed with one filter cycle that will run in the evening (assuming the time-of-day is properly set) when energy rates are often lower. The filter time and duration are programmable. (see page 51)

A second filter cycle can be enabled as needed.

At the start of each filter cycle, the water devices like blower, mister device (if these exist) and other pumps will run briefly to purge the plumbing to maintain good water quality.

### **Freeze Protection**

If the temperature sensors within the heater detect a low enough temperature, then the water devices automatically activate to provide freeze protection. The water devices will run either continuously or periodically depending on conditions. In colder climates, an optional freeze sensor may be added to protect against freeze conditions that may not be sensed by the standard sensors. Auxiliary freeze sensor protection acts similarly except with the temperature thresholds determined by the switch. See your dealer for details.



## Time of Day

### Set the Time-of-Day

Setting the time-of-day is important for determining filtration times and other background features.

The Time Icon  on the Settings Screen takes you to a screen where you control the Time-of-Day.

On the Time-of-Day screen, simply select the Hours and Minutes. Use the Up and Down Buttons to make changes, then Save.



If no time-of-day is set in the memory an Information Screen will appear. If you exit it and Information Icon will appear at the bottom of the Main Screen, until the time-of-day has been set.



Note:

This only applies to some systems:

If power is interrupted to the system, Time-of-Day will be maintained for several days.

## Adjusting Filtration

### Main Filtration

Using the same adjustment as Setting the Time, Filter Cycles are set using a start time and a duration. Each setting can be adjusted in 15-minute increments.

The Filter Icon  on the Settings Screen takes you to a screen where you control the Filter Cycles.

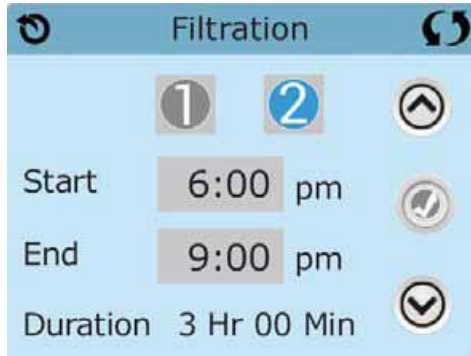

### Filter Cycle 2 - Optional Filtration

Filter Cycle 2 is OFF by default.

It is possible to overlap Filter Cycle 1 and Filter Cycle 2, which will shorten overall filtration by the overlap amount.

#### Viewing Filter 1 while Filters 2 is Off



#### Viewing Filter 1 while Filter 2 is On



Press "1" to view Filter 1. Press "2" once to view Filter 2. Press "2" again to turn Filter 2 ON or OFF.

When Filter Cycle 2 is ON, it can be adjusted in the same manner as Filter Cycle 1.

It is possible to overlap Filter Cycle 1 and Filter Cycle 2, which will shorten overall filtration by the overlap amount.

### **Circulation Pump Modes**

Some spas may be manufactured with Circ Pump settings that allow programming filtration cycle duration.

### **Purge Cycles**

In order to maintain sanitary conditions, as well as protect against freezing, secondary water devices will purge water from their respective plumbing by running briefly at the beginning of each filter cycle. (Some systems will run a certain number of purge cycles per day, independent of the number of filter cycles per day. In this case, the purge cycles may not coincide with the start of the filter cycle.)

If the Filter Cycle 1 duration is set for 24 hours, enabling Filter Cycle 2 will initiate a purge when Filter Cycle 2 is programmed to begin.

### **The Meaning of Filter Cycles**

1. The heating pump always runs during the filter cycle\*
2. In Rest Mode, heating only occurs during the filter cycle
3. Purges happen at the start of each filter cycle

\* For example, if your spa is set up for 24 hour circulation except for shutting off when the water temperature is 3 °F (1.3 °C) above the set temperature, that shutoff does not occur during filter cycles.

### **Additional Settings**

#### **Light Cycle Option**

If Light Cycle does not appear on the Settings Screen, the Light Timer feature is not enabled by the manufacturer.

The Light Cycle Icon  on the Settings Screen takes you to a screen where you control the Light Cycle.

When available, the Light Timer is (“Disabled”) by default. Press “Disabled” to change it to “Enabled” (ON).

The settings can be edited the same way that Filter Cycles are edited (see page 51).



## Auxiliary Panels

### Specific Buttons for Specific Devices

If the spa has an Auxiliary Panel(s) installed, pressing buttons on that panel will activate the device indicated for that button.

These dedicated buttons will operate just like the Spa Screen buttons (see page 42) and the equipment will behave in the same manner with each button press.

### Restricting Operation

The control can be restricted to prevent unwanted use or temperature adjustments.

Locking the Panel prevents the controller from being used, but all automatic functions are still active.

Locking the Settings allows Jets and other features to be used, but the Set Temperature and other programmed settings cannot be adjusted.

Settings Lock allows access to a reduced selection of menu items.

These include Filter Cycles, Invert, Information and Fault Log.

They can be seen, but not changed or edited.



## Locking and Unlocking

The same steps are used to Lock and Unlock.

To lock either Settings or Panel first select Settings (if it says “Unlocked”) or Panel (if it says “Unlocked”), then press the word “Lock“ for at least 5 seconds.

To unlock either Settings or Panel first select Settings (if it says “Locked”) or Panel (if it says “Locked”), then press the word “Lock“ for at least 5 seconds.

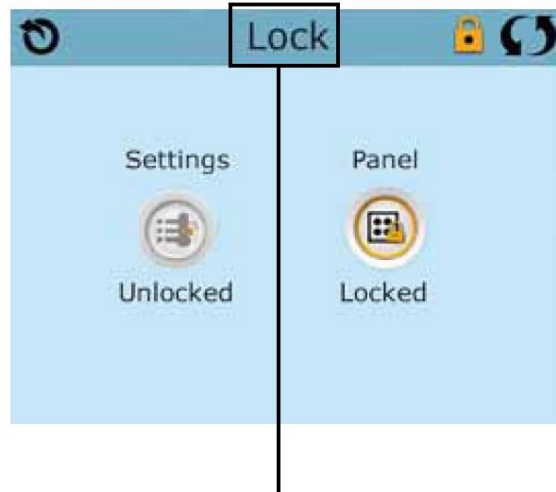

Press here for 5 seconds  
to lock or unlock.

## Additional Settings

\* M0XX is a Message Code. Codes like this will be seen in the Fault Log.

### Hold Mode – M037\*

Hold Mode is used to disable the pumps during service functions like cleaning or replacing the filter. Hold Mode will last for 1 hour unless the mode is exited manually. If spa service will require more than an hour, it may be best to simply shut down power to the spa.

The Hold Icon  on the Settings Screen places the spa in Hold Mode and displays the System Hold screen.

Touch Back to exit Hold Mode.



## Utilities

The Utilities Icon on the Settings Screen takes you to the Utilities Screen.

The Utilities Screen contains the following:

### Panel

Touching the Panel Icon on the Utilities Screen takes you to the Panel Screen, where you can set how long it takes the panel to go to sleep after the last activity.



The Sleep Timer can be set from 1 minute to 60 minutes.

The default is 30 minutes.



## Fault Log

The Fault Log is a record of the last 24 faults that can be reviewed by a service tech.

Use the Up and Down buttons to view each of the Faults.

When Priming Mode shows in the Fault Log, it is not a fault. Rather, it is used to keep track of spa restarts.

## GFCI Test

(Feature not available on CE rated systems.)

Your systems may have GFCI configured in one of three ways:

1. GFCI test is not enabled
2. Manual GFCI test is enabled but automatic GFCI test is not enabled
3. Both manual and automatic GFCI tests are enabled. The automatic test will happen within 7 days of the spa being installed and if successful will not repeat. (If the automatic test fails it will repeat after the spa is restarted.)

GFCI Test will not appear on the screen if it is not enabled. This screen allows the GFCI to be tested manually from the panel and can be used to reset the automatic test feature. (see page 59)

## Units Screen

The Units Icon  on the Settings Screen takes you to the Units Screen.

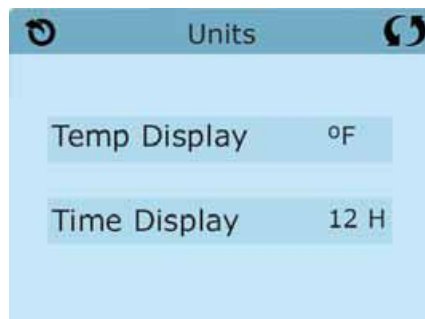

Press “Temp Display” to change the temperature between Fahrenheit and Celsius.

Press “Time Display” to change the clock between 12 hr and 24 hr display.

## Reminders

The Reminder Icon  on the Settings Screen takes you to the Reminders screen.

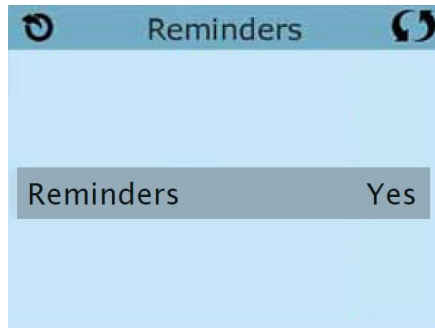

Press “Reminders” to turn the reminder messages (like “Clean Filter”) ON (Yes) or OFF (No).

### Cleanup Cycle

Cleanup Cycle Duration is not always enabled, so it may not appear. When it is available, set the length of time Pump 1 will run after each use. 0-4 hours are available. Setting it to 0.0 Hr keeps the Cleanup Cycles from running.

The Cleanup Icon  on the Settings Screen takes you to the Cleanup Cycle screen.

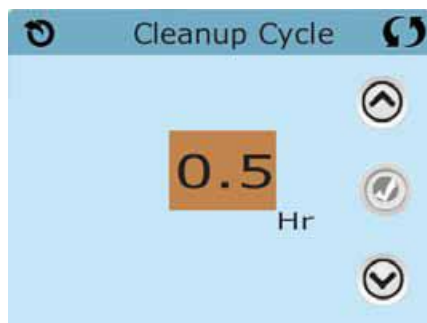

### Language

The Language Icon on the Settings Screen takes you to the Language screen.

Change the language displayed on the panel.

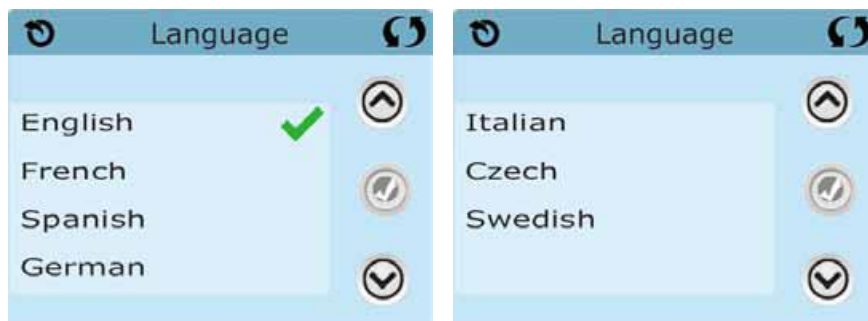



## Information

### System Information

The System Information Screen displays various settings and identification of the particular system.

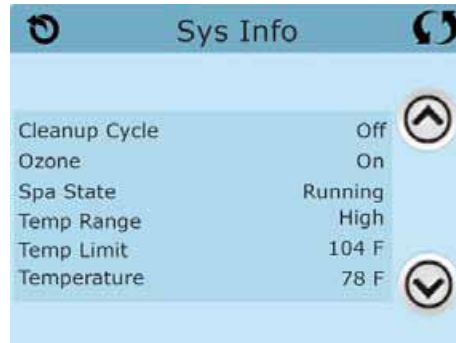

### System Model

Displays the Model Number of the System.

### Panel Version

Displays a number of the software in the topside control panel.

### Software ID (SSID)

Displays the software ID number for the System.

### Configuration Signature

Displays the checksum for the system configuration file.

### Current Setup

Displays the currently selected Configuration Setup Number.

### Dip Switch Settings

Displays a number that represents the DIP switch positions of S1 on the main circuit board.

### Heater Voltage (Feature not used on CE rated systems.)

Displays the operating voltage configured for the heater.

### Heater Wattage as Configured in Software (CE Systems Only.)

Displays a heater kilowatt rating as programmed into the control system software (1-3 or 3-6).

### **Heater Type**

Displays a heater type ID number.

### **GFCI Test Feature**

The Ground Fault Circuit Interrupter (GFCI) or Residual Current Detector (RCD) is an important safety device and is required equipment on a hot tub installation.

(The GFCI Test Feature is not available on CE rated systems.)

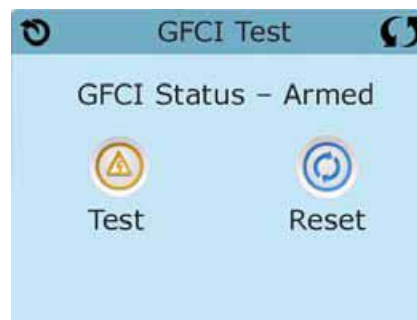

### **Used for verifying a proper installation**

Your spa may be equipped with a GFCI Protection feature. If your spa has this feature enabled by the manufacturer, the GFCI Trip Test must occur to allow proper spa function.

On some systems:

Within 1 to 7 days after startup, the spa will trip the GFCI to test it. (The number of days is factory programmed.) The GFCI must be reset once it has tripped. After passing the GFCI Trip Test, any subsequent GFCI trips will indicate a ground fault or other unsafe condition and the power to the spa must be shut off until a service person can correct the problem.

### **Forcing the GFCI Trip Test (North America Only)**

Touching the GFCI Test Icon on the Utilities Screen takes you to the GFCI Test screen.

The installer can cause the GFCI Trip Test to occur sooner by pressing Test on the GFCI Test screen.

The GFCI should trip within several seconds and the spa should shut down. If it does not, shut down the power and manually verify that a GFCI breaker is installed and that the circuit and spa are wired correctly. Verify the function of the GFCI with its own test button. Restore power to the spa and repeat the GFCI Trip Test.

Once the GFCI is tripped by the test, reset the GFCI and the spa will operate normally from that point. You can verify a successful test by navigating to the above screen. “Passed” should appear after the Reset line is selected on the GFCI screen.

**Warning:**

On those systems that automatically test the GFCI within 1 to 7 days after startup:

The end-user must be trained to expect this one-time test to occur.

The end-user must be trained how to properly reset the GFCI.

If freezing conditions exist, the GFCI or RCD should be reset immediately or spa damage could result.

**CE Product:**

CE registered systems do not have an RCD Test Feature due to the nature of the electrical service.

Some UL registered systems do not have the GFCI Test Feature activated.

The end-user must be trained how to properly test and reset the RCD.

**Reset Button:**

Only use the Reset Button prior to moving the spa to a new location.

Pressing the Reset the button forces a new Test to be performed at the new location.

**General Messages**

Most messages and alerts will appear at the bottom of the normally used screens. Several alerts and messages may be displayed in sequence. Some messages can be reset from the panel. Messages that can be reset will appear with a “right arrow” at the end of the message. This message can be selected by navigating to it and pressing the select button.

--°F --°C

**Water Temperature is Unknown**

After the pump has been running for 1 minute the water temperature will be displayed.



### **Possible Freezing Condition**

A potential freeze condition has been detected. All water devices are activated. In some cases, the pump may turn on and off and the heater may operate during Freeze Protection. This is an operational message, not an error code.

\*M0XX is a Message Code. Codes like this will be seen in the Fault Log.

### **The Water is Too Hot – M029\***

The system has detected a spa water temperature of 110 °F (43.3 °C) or more, and spa functions are disabled. System will auto reset when the spa water temperature is below 108°F (42.2°C). Check for extended pump operation or high ambient temperature. During the warmer months, changing the filter cycle is recommended to prevent the spa from overheating with the high ambient temperature.

### **The Water Level is Too Low**

This message can only appear on a system that uses a water level sensor. It appears whenever the water level get too low (or the water level sensor is disconnected), and automatically disappears when the water level is adequate. Pumps and the heater turn OFF when this message appears.

### **The Water Flow is Low – M016\***

There may not be enough water flow through the heater to carry the heat away from the heating elements. Heater startup will begin again after about 1 minute.

### **Flow-Related Checks**

Check for low water level, suction flow restriction (filters), closed valves or trapped air.

### **The Water Flow has Failed – M017\***

There is not enough water flow through the heater to carry the heat away from the heating element and the heater has been disabled. After the flow problem has been resolved you must press any button to reset and begin the heater start up.

### **Flow-Related Checks**

Check for low water level, suction flow restriction (filters), closed valves, or trapped air.

### The Heater May be Dry – M028\*

Possible dry heater or not enough water in the heater to start it. The spa is shut down for 15 minutes. Press any button to reset the heater startup.

#### Flow-Related Checks

Check for low water level, suction flow restriction (filters), closed valves, or trapped air.

### The Heater is Dry – M027\*

There is not enough water in the heater to start and the spa is shut down. After the problem has been resolved, you must clear the message to restart the heater.

#### Flow-Related Checks

Check for low water level, suction flow restriction (filters), closed valves, or trapped air.

### The heater is too hot – M030\*

One of the water temperature has detected 118 °F (47.8 °C) in the heater and the spa is shut down. You must clear the message when water is below 108 °F (42.2 °C).



#### Flow-Related Checks

Check for low water level, suction flow restriction (filters), closed valves, or trapped air.

\* Some messages can be reset from the panel. Messages that can be reset will appear with a Clear Icon at the bottom of the Message Screen. Press the Clear Icon text to reset the message.

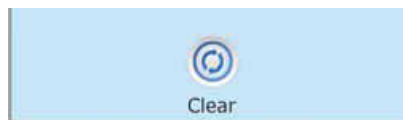

## Sensor Related Messages

### Sensors Are Out of Sync – M015\*

The temperature sensors may be out of sync. Call your dealer for service.

**Sensors Are Out of Sync – Call for Service – M026\***

The temperature sensors are out of sync. Call your dealer for service.

**Sensor A Fault, Sensor B Fault – Sensor A: M031\*, Sensor B: M032\***

The temperature sensors or sensor circuit has failed. Call your dealer for service.

**System Related Messages**

**Program Memory Failure – M022\***

Call your dealer for service.

**The Settings Have Been Reset – M021\***

Call your dealer for service if this message appears on more than one power-up.

**The Clock has Failed – M020\***

Call your dealer for service.

**Configuration Error (Spa Will not Start)**

Call your dealer for service.

**The GFCI Test Failed (System Could Not Test the GFCI) – M036\* (North America Only)**

May indicate an unsafe installation. Call your dealer for service.

**A Pump May be Stuck On – M034\***

Water may be overheated.

**POWER DOWN THE SPA! DO NOT ENTER THE WATER!**

Call your dealer for service.

**Hot Fault – M035\***

A pump appears to have been stuck on when the spa was last powered on. Water may be overheated.

**POWER DOWN THE SPA! DO NOT ENTER THE WATER!**

Call your dealer for service.

## **Miscellaneous Messages**

### **Communications Error**

The control panel is not receiving communication from the system. Call your dealer for service.

### **Test Software Installed**

The Control System is operating with test software. Call your dealer for service.

### **°F or °C is replaced by °T**

The Control System is in Test Mode. Call your dealer for service.

## **Reminder Messages**

Not all messages may display.

### **Check the pH**

May appear on a regular schedule, i.e. every 7 days. Check pH with a test kit and adjust pH with the appropriate chemicals.

### **Check the Sanitizer**

May appear on a regular schedule, i.e. every 7 days. Check sanitizer level and other water chemistry with a test kit and adjust with the appropriate chemicals.

### **Clean the Filter**

May appear on a regular schedule, i.e. every 30 days. Clean the filter media as instructed by the manufacturer.

### **Test the GFCI (or RCD)**

May appear on a regular schedule, i.e. every 30 days. The GFCI or RCD is an important safety device and must be tested on a regular basis to verify its reliability. Every user should be trained to safely test the GFCI or RCD associated with the hot tub installation.

### **Change the Water**

May appear on a regular schedule, i.e. every 90 days. Change the water in the spa on regular basis to maintain proper chemical balance and sanitary conditions.

### **Clean the Cover**

May appear on a regular schedule, i.e. every 180 days. Vinyl covers should be cleaned and conditioned for maximum life.

### **Change the Filter**

May appear on a regular schedule, i.e. every 365 days. Filters should be replaced occasionally to maintain proper spa function and sanitary condition.

## MAINTAINING THE SWIM SPA AND EXERCISE POOL

### Draining the Swim Spa and Exercise Pool

The swim spa and exercise pool needs to be drained, cleaned, waxed, and refilled about every six months. More frequent water changes may be necessary if bather load is heavy. A hose bib has been provided to assist in draining the swim spa and exercise pool.



Figure 24. Hose Bib Opening Instructions

- 1) Turn off the power to the swim spa and exercise pool. Failing to turn the power off, could cause vital components to be damaged. Do not leave an empty swim spa and exercise pool exposed for long periods of time in hot, sunny weather.
- 2) Pull tab and then turn counter clockwise till cap is removed.
- 3) Connect the hose to hose bib.
- 4) Pull hose bib out to ensure opening of nozzle/drain plug.
- 5) Check the garden hose end to see if water is flowing. If water is not flowing, check the hose for kinks. Also check to see if the valve is in the full open position.



**CAUTION:** The chemical content and temperature of the water will cause damage to certain vegetation. Draining the swim spa and exercise pool onto plants or lawns is not recommended. When choosing to do this, please remove the swim spa and exercise pool cover and allow swim spa and exercise pool to cool for a minimum of 24 hours with the swim spa and exercise pool turned off.

## **Pillow Care**

Remove and clean the pillows with soapy water and a soft cloth when needed. Use a vinyl conditioner once a month. Remove pillows when doing chemical shock treatment.

## **Jet Care**

Cleaning the jets when draining the swim spa and exercise pool is recommended.

- 1) Spray jet inserts with a mixture of 1 part vinegar to two parts warm water and let soak for 10 – 15 minutes. Periodically rotate the spinner nozzle to break up residue in the jets.



Rinse the jet inserts with a standard garden hose.



## Removing, Installing and Cleaning Filters

These are the steps needed to properly replace the filters. Disposable swim spa and exercise pool filters should be replaced or non-disposable filters should be cleaned every four months.



- 1) Turn off all power to the swim spa and exercise pool and remove the filter lid by lifting it out towards you.
- 2) Turn the filter counterclockwise and remove it from the filter well.
- 3) Dispose of the used filter.
- 4) To replace, set screen back into its place and turn clockwise to fasten. DO NOT over-tighten.
- 5) Place the new filter into position and turn clockwise to fasten. DO NOT overtighten.

- 6) Use of a quality filter soak product is recommended. Please contact your dealer to purchase swim spa and exercise pool and exercise pool care products.

**NOTE: Only use TidalFit™ approved filters. Using a non TidalFit™ approved filter can cause issues with the circulation system and heater and can void warranty coverage.**

**WARNING: Power to the swim spa and exercise pool must be turned off prior to removing the filters. The suction at the filter is extremely strong and can cause injury if there is no filter. NEVER run the swim spa and exercise pool without the filters properly installed. Injury to person and damage to the equipment can occur. Any damage to equipment due to this circumstance will not be covered under warranty.**

## **Storing or Winterizing the Swim Spa and Exercise Pool**

An emptied swim spa and exercise pool (without water) must not be exposed to direct sunlight as acrylic shell damage may occur to UV radiation. It is not recommended that the swim spa and exercise pool be drained completely during freezing conditions. Leaving the swim spa and exercise pool full of water with the power on is recommended to keep the tub from freezing. If you decide to drain the swim spa and exercise pool during freezing conditions, contact your local authorized dealer for assistance.

Contact your TidalFit™ dealer before refilling a drained swim spa and exercise pool in freezing temperatures.

**WARNING: Damage to the swim spa and exercise pool caused by freezing is NOT covered under warranty. Please contact your local TidalFit™ dealer to assist you in winterizing the swim spa and exercise pool.**

## **Swim Spa and Exercise Pool Cabinet Care**

The swim spa and exercise pool comes standard with a Grandwood, or faux wood, cabinet. This cabinet requires no maintenance. You may wish to clean the cabinet with mild soap and water from time to time.

Gently wash the cabinet with mild soap and water and allow to dry completely.

**Do not apply any solid type finish such as shellac or varnish. After weathering, these types of finishes will crack and/or turn yellow.**

## **Cleaning the Swim Spa and Exercise Pool Interior**

It is important to clean the interior of the swim spa and exercise pool every time it is drained to help preserve the sheen of the swim spa and exercise pool's surface. However, it is important that you do not use any abrasive cleaners or strong chemicals. Your TidalFit™ authorized dealer will be able to supply you with the proper cleaning

solution the swim spa and exercise pool. After cleaning, make sure all residues are removed prior to filling the swim spa and exercise pool. This will help prevent sudsing and improper chemical balance.

## **Swim Spa and Exercise Pool Cover Use, Installation and Care**

The swim spa and exercise pool cover has tie down straps and locking hardware at each corner to securely fasten the cover to the swim spa and exercise pool cabinet. Proper cover lock installation instructions are included with the cover to ensure compliance with the ASTM F1346-91 safety standard for swim spa and exercise pool covers.

The spa cover has tie down straps and locking hardware at each corner to securely fasten the cover to the spa cabinet. Proper cover lock installation instructions are included with the cover to ensure compliance with the ASTM F1346-91 safety standard for spa covers.

Weather Shield is a solution dyed polyester fabric designed to be flexible and easy for manufacturers to use. Its urethane coating enhances the stability of the weave and allows for greater water resistance, while also minimizing shrinkage and stretching. Weather Shield features a high UV, water and mold and mildew resistance and has excellent tear and abrasion resistance.

**Never stand or sit on the cover while on or off of the spa and never drag it over abrasive surfaces. Lift cover only by the handles provided.**

### **CARE & CLEANING.**

Weather Shield is designed to be easy to maintain. It can be washed, or brushed off and rinsed. Proper care and cleaning is important to the life of all fabrics.

#### **FOR NORMAL CARE AND CLEANING.**

Add 2 ounces of mild soap such as Woolite or Dawn dishwashing liquid to 1 gallon of lukewarm water. Clean the fabric with a "soft bristle brush." Rinse thoroughly with cold water and air dry.

#### **FOR STUBBORN STAINS.**

Add maximum 1 cup of bleach to one 1 gallon of water. Spray on lightly to the fabric face (non-coated side). Do not soak fabric. Prolonged exposure to harsh chemicals can damage the coating. Rinse immediately. Do not leave on for more than 2 minutes. Cleaning with harsh cleaners such as bleach will require a retreatment like 303 High Tech Fabric Guard for restoring water repellency.

## Caring For Your Spa Cover

A proper and diligent spa cover care routine can certainly be the difference between you needing to buy another cover in 3-4 years instead of it lasting 5-7 years. Here are some tips to get the most out of your new spa cover purchase.

- Keep the cover clean.
- Wipe chemical residue from the underside of the cover every chance you get. These residues, if left on the cover, start to break down the material causing it to become porous. Water vapor begins to penetrate the EPS core when its protective layer become too porous.
- Maintain proper spa water chemistry. We cannot stress this enough. As your spa water chemistry is more balanced, the vapors coming off the tub are less corrosive. Making the vapors less corrosive leads to the protective layers of the cover to degrade more slowly, thus prolonging the life of your cover. Failing to maintain proper water chemistry may void your warranty.
- Unzip the cover and clean just inside the zipper at least twice per year. Mildew has a tendency to build up here and if you have not kept your sanitizer levels up you may develop this as a problem. Use a weak amonia and water solution.
- Remove the EPS cores and flip them over at least once per year. The cover is a protective layering system designed to slow the EPS core absorption of water vapor. The corrosive vapors formed in your spa break down these layers over time. By flipping the cores over, you start to work on the other side of the protective wrap on the core.
- Remove the cover for 20-30 minutes after shocking your spa water. As the shock is burning out the Chloramines and Bromamines in your spa, highly corrosive vapors are released. Following this tip will protect your covers materials from premature degradation.
- Completely remove the cover at least once per week to allow the water to drain out of it. Always completely remove the cover while using your hot tub. We highly discourage the practice of only opening one half of the cover while bathing in your spa.
- Use a floating thermal blanket in addition to the traditional hard-shell insulating cover. Floating covers, by bringing a layer of insulation to water level, drastically cut down on evaporation. Evaporation is the primary delivery vehicle for bringing the chemicals and contaminants to the cover. Cutting down evaporation reduces the amount of damage done to the cover.

## Chemical Treatment of Water

Water from the tap is fine for showers, bathing and drinking. However, in a contained recirculating system such as in a swim spa and exercise pool, water must be treated with chemicals. The main purpose of chemical treatment is to keep the water sanitary

and to maintain a specific pH balance of the water. Proper pH balance ensures that the water will not cause irritation to the users or harm the swim spa and exercise pool's components. Chemical treatment does have its limitations. When water evaporates, chemical residues are left behind.

As the levels of the residues combine with other types of residue, such as body oil and detergents, the water becomes increasingly difficult to maintain. Because of this residual effect, at some point it becomes easier and more cost effective to drain, clean and refill the swim spa and exercise pool with new water. We recommend that the water be changed at least every six months. At this time you should also clean or replace the filters. If the swim spa and exercise pool has a frequent and/or heavy bather load, it may be necessary to drain and fill the swim spa and exercise pool more often. Refer to the section titled "Draining the Swim Spa and Exercise Pool" for instructions on page 65. **WARNING: Swim spa and exercise pool damage due to improper chemicals use is not covered under warranty.**

## **TIDALFIT™ WARRANTY**

This section is a description of the warranty, what is covered under the TidalFit™ swim spa and exercise pool warranty and conditions that can void the warranty. **PLEASE READ THE WARRANTY THOROUGHLY.** Please take a moment to register your warranty. You can register on line at <http://www.TidalFit.com>, click on SUPPORT or mail in the warranty registration card attached to this manual. For warranty information outside of the USA and Canada, please refer to your country's TidalFit™ Distributor.

### **LIFETIME STRUCTURE WARRANTY**

TidalFit™ carry a lifetime structure warranty. The structure is defined as the fiberglass vessel below the exposed material finish. The manufacturer warrants the swim spa and exercise pool against loss of water due to a defect in the swim spa and exercise pool structure, for the lifetime of the swim spa and exercise pool. In the event of a defect in the material and/or workmanship, the swim spa and exercise pool structure will be repaired or replaced at the discretion of the manufacturer. **THIS WARRANTY IS GIVEN ONLY TO THE ORIGINAL OWNER, AND TERMINATES UPON TRANSFER OF OWNERSHIP. COMMERCIAL APPLICATIONS ARE EXCLUDED FROM THIS AND ALL WARRANTIES.**

If the swim spa and exercise pool structure is defective and must be replaced, it will be returned to the factory. The original, installed equipment (this includes the frame, skirt, and all equipment) will be reinstalled. If new equipment is desired, there will be additional charges to the customer. If the frame and/or skirt of the swim spa and exercise pool has been badly damaged, there will be additional charges to the swim spa and exercise pool owner for repairs or replacement. When a swim spa and exercise pool needs to be returned to the factory for repair, the cost of one way freight to the company will be at the swim spa and exercise pool owner's expense. The manufacturer

will not pay for removal, installation, cranes, construction, de-construction, or any other cost associated with access, egress, or ingress, of the swim spa and exercise pool at the customer's home. The manufacturer reserves the right to an on-site inspection by its authorized representative. In the unlikely event a shell or swim spa and exercise pool must be replaced, all warranties (shell, surface, electrical and plumbing) date back to the original start date of the warranty. The warranty period starts either the day of delivery to the customer or eighteen (18) months from the date of manufacturing, whichever date comes first.

## **SEVEN YEAR SURFACE WARRANTY**

The swim spa and exercise pool surface is described as the exposed acrylic material finish. The manufacturer warrants the swim spa and exercise pool surface to be free from defects in the material and workmanship, such as blistering, cracking, or delaminating, this does not cover micro-crazing, under normal use and maintenance for a period of seven years from the original date of the warranty. The warranty period starts either the day of delivery to the customer or eighteen (18) month from the date of manufacturing, whichever date comes first. **THIS WARRANTY IS ONLY AVAILABLE TO THE ORIGINAL OWNER, AND TERMINATES UPON TRANSFER OF OWNERSHIP. COMMERCIAL APPLICATIONS ARE EXCLUDED FROM THIS AND ALL WARRANTIES.**

The swim spa and exercise pool must be set on a level solid surface that is sufficient to support the entire length and width of the swim spa and exercise pool. Standard building practices must be followed. Damage caused by failure to have a leveled and supported foundation under the swim spa and exercise pool is not covered under warranty. The manufacturer does not warrant problems associated with prolonged exposure to the sun and/or use of any sanitization or ozone system not approved by the manufacturer. Damage to the swim spa and exercise pool surface caused by leaving the swim spa and exercise pool uncovered and empty of water with direct sunlight exposure will terminate this warranty. Any alteration to any system, either electrical, plumbing, or mechanical, or over use of chemicals, or any other problems caused by external source are not covered under warranty. Other exclusions may apply.

Normally problems associated with material and workmanship can and will be repaired. If the swim spa and exercise pool surface is repaired, the repair is limited to the affected area only, and there is no guarantee against discoloration or fading. The decision to repair will be made by the manufacturer and its field representative after a review of the facts, pictures, or any other data presented by the dealer or customer. In all cases, pictures of the affected area and foundation of the swim spa and exercise pool must be provided before any decisions to repair or replace can be made. In the unlikely event a shell or swim spa and exercise pool must be replaced, all warranties (shell, surface, electrical and plumbing) date back to the original date of installation. If it is determined that the surface is to be replaced, the same conditions and terms as outlined in the shell warranty will apply.





## **FIVE YEAR ELECTRICAL WARRANTY**

(i.e., pumps, equipment packs, heaters, topside, etc.)

The MANUFACTURER warrants all electrical equipment to be free from defect in material and workmanship for five years from the original start date of the warranty. The warranty period starts either the day of delivery to the customer or eighteen (18) month from the date of manufacturing, whichever date comes first. **THIS WARRANTY IS GIVEN ONLY TO THE ORIGINAL CONSUMER AND TERMINATES UPON TRANSFER OF OWNERSHIP. COMMERCIAL APPLICATIONS ARE EXCLUDED FROM THIS AND ALL WARRANTIES.**

The stereo, speakers, L.E.D. lighting, and Ozone are not included in this warranty but are covered under a separate warranty. Damage caused by acts of nature, poor water chemistry, and/or improper maintenance will not be covered under this warranty. Alterations or replacements of components installed in the swim spa and exercise pool that are not purchased and/or approved by the MANUFACTURER, including incorrect wiring, will terminate the complete spa warranty.

## **FIVE YEAR PLUMBING WARRANTY**

The plumbing is described as all piping, jet bodies, valve bodies and air controls. The manufacturer warrants all plumbing for a period of five years from the original start date of the warranty. The warranty period starts either the day of delivery to the customer or eighteen (18) month from the date of manufacturing, whichever date comes first. **THIS WARRANTY IS GIVEN ONLY TO THE ORIGINAL OWNER, AND TERMINATES UPON TRANSFER OF OWNERSHIP. COMMERCIAL APPLICATIONS ARE EXCLUDED FROM THIS AND ALL WARRANTIES.** Jet internals, valve handles, and other such items are regular maintenance items. They are covered for the item only, labor is not covered for these items. Damage caused by acts of nature, poor water chemistry, and/or improper maintenance will not be covered under this warranty.

## **TWO YEAR GRANDWOOD CABINET WARRANTY**

The swim spa and exercise pool cabinet is described as the outer material encasing the swim spa and exercise pool structure. The manufacturer warrants it to be free from defects in material and/or workmanship for a period of two years from the original start date of the warranty. The warranty period starts either the day of delivery to the customer or eighteen (18) month from the date of manufacturing, whichever date comes first. **THIS WARRANTY IS GIVEN ONLY TO THE ORIGINAL OWNER, AND TERMINATES UPON TRANSFER OR OWNERSHIP.**

**COMMERCIAL APPLICATIONS ARE EXCLUDED FROM THIS AND ALL WARRANTIES.** This warranty does not cover normal darkening, staining, or aging. The swim spa and exercise pool cabinet requires care and maintenance by the consumer. Damage caused by acts of nature, poor water chemistry, and/ or improper maintenance will not be covered under this warranty.

## **OTHER ITEMS NOT COVERED IN THIS WARRANTY**

Some items are not covered in this warranty. These items either have a different warranty, or are warranted through the manufacturer of that item.

## **STEREO AND STEREO COMPONENTS**

The stereo and stereo components, including speakers, Bluetooth®, subwoofer, stereo power supply, wire harness and remote control are covered for 30 days from the original start date of the warranty. The warranty period starts either the day of delivery to the customer or eighteen (18) month from the date of manufacturing, whichever date comes first. Please note: Warranty coverage for both parts and labor is covered for 30 days only. Parts, not labor, will be covered for one year from date of installation. This warranty does not cover damage to a stereo or stereo component from abuse, poor reception, or damage caused by putting a wet CD into the stereo. If a stereo is replaced under this warranty, the manufacturer reserves the right to replace the unit with another like unit, but not necessarily the same stereo manufacturer. No swim spa and exercise pool will be replaced for a failed stereo. The stereo does not affect the performance of the swim spa and exercise pool.

**NOTE: For all operating instructions see the stereo manufacturer's owner's manual included with the swim spa and exercise pool.**

## **OZONATOR**

The ozonator is covered for one year from the original start date of the warranty. The warranty period starts either the day of delivery to the customer or eighteen (18) month from the date of manufacturing, whichever date comes first.

## **SWIM SPA AND EXERCISE POOL COVER**

The swim spa and exercise pool cover manufacturer warrants the swim spa and exercise pool cover skin for one year from the original start date of the warranty. The warranty period starts either the day of delivery to the customer or eighteen (18) month from the date of manufacturing whichever date comes first.

Do not return the swim spa and exercise pool cover to the manufacturer. This will delay the replacement or repair of the cover. The swim spa and exercise pool manufacturer is not responsible for lost covers.

## **LIGHTING**

The lighting is guaranteed to work upon delivery. There is no warranty covering the lighting.

## **PERFORMANCE**

In the event of any defect covered by this LIMITED warranty, a May Manufacturing LLC, authorized agent will correct such defect within the terms and conditions contained

herein. There will be no charge for parts or labor within the above terms. However, travel charges that occur will not be covered under terms and conditions by the warranty. If it is determined by May Manufacturing LLC that the repair of the product is not feasible, a replacement swim spa and exercise pool equal to the value of the original purchase price will be provided. Cost for removal of the defective swim spa and exercise pool and delivery and installation of the replacement swim spa and exercise pool is the responsibility of the homeowner and will not under any circumstances be covered by May Manufacturing, LLC dba TidalFit™.

## **LIMITATIONS**

This warranty is void if this TidalFit™ has been subjected to alteration, misuse, or repairs have been performed by anyone other than an authorized agent of May Manufacturing LLC. Misuse or abuse is defined as: use of the swim spa and exercise pool in a nonresidential application, water temperature outside the range of 32 °F to 110 °F, damage caused by clogged or dirty filter cartridges, damage to the swim spa and exercise pool from an absence of a hard cover, damage to components from improper pH, use of any type of acid, or from chemical imbalance. ACTS OF NATURE are not covered under this warranty.

NOTE: Warranty on 50 Hz swim spa and exercise pools excludes labor.

(Outside US and Canada)

## **DISCLAIMER**

May Manufacturing LLC dba TidalFit™, or its agents shall not be liable for any injury, cost or other damage, whether incidental or consequential, arising out of any defect covered by the LIMITED WARRANTY. The liability of May Manufacturing, LLC dba TidalFit™ under this LIMITED WARRANTY shall not exceed the original amount paid for the swim spa and exercise pool.

## **LEGAL REMEDIES**

This LIMITED WARRANTY gives specific rights, and other rights that may apply and will vary from state to state.

## **WHAT IS NOT COVERED UNDER THE WARRANTY**

The following is a general overview of non-warranty items and work. This is not an all-inclusive list.

Diagnosis of Swim Spa and Exercise Pool Problems

Fuses

Light Bulbs of Any Kind

Removing a Swim Spa and Exercise Pool from a Structure

Pillows

Filters

Chemical Misuse/ Damage

Filter Lids

Any Part Not Purchased from TidalFit™

Jet Inserts Valve Handles Pump Seals

Draining and filling the Swim spa and Exercise Pool

Acts of Nature Travel Charges Cabinet Screws Incorrect Wiring Shipping Charges

By Using Non-Artesian Parts

**THIS WARRANTY IS GIVEN ONLY TO THE ORIGINAL OWNER, AND TERMINATES UPON TRANSFER OF OWNERSHIP. COMMERCIAL APPLICATIONS ARE EXCLUDED FROM THIS AND ALL WARRANTIES.**

Any alteration of the swim spa and exercise pool that has not been pre-authorized by the manufacturer will void all warranties. If the manufacturer approves an alteration, verify that this alteration is covered under warranty. Damage caused by moving a swim spa and exercise pool that is blocked in or that has been recessed, along with additional charges for labor, is not covered by this warranty.



---

---

---

Please do not send products or other correspondence to the address below.

Place  
Stamp  
Here

**ARTESIAN SPAS**  
Attn: Customer Care Department  
4720 N. Lamb Blvd.  
Las Vegas, NV 89115

### SPA & WARRANTY REGISTRATION

#### Activate Product Warranty & Download Owner's Manuals

Please activate your warranty and register your spa at [www.TidalFit.com](http://www.TidalFit.com), under SUPPORT, Click Owners.  
or mail in the registration card in the back of the Owner's Manual.

*(Serial # is required below and can be located on the bottom kick plate of the spa, or can be found within the cabinet next to the equipment on a white placard attached to the frame.)*

Name \_\_\_\_\_ Email \_\_\_\_\_

Address \_\_\_\_\_

City \_\_\_\_\_ State \_\_\_\_\_ Zip \_\_\_\_\_

Phone Number \_\_\_\_\_

Date of Installation \_\_\_\_\_ Spa Serial Number (required) \_\_\_\_\_

Spa Model \_\_\_\_\_

Your Dealers Name and Location \_\_\_\_\_

#### Optional Questions:

What other spa brands did you consider buying? \_\_\_\_\_

How many people are in your household? \_\_\_\_\_

What is your age bracket? 25-30  31-40  41-50  51-60  61-70  71+

What is your reason for purchasing a spa?  Health Benefits  Stress  Relief  Relaxation

Other: \_\_\_\_\_







4720 N. Lamb Blvd.  
Las Vegas, Nevada 89115  
[www.TidalFit.com](http://www.TidalFit.com)